

3.0 SETTING

This chapter presents the existing environmental setting for the project against which potential impacts of the project have been evaluated. This EIR is focused only on the environmental topics identified in the IS (Appendix A) that could be significantly adversely affected by the proposed project. The reader is referred to the IS for discussion of environmental topics not considered in this EIR and the rationale for inclusion or exclusion of each environmental topic. In the interest of reducing paperwork and not repeating readily available information, the reader is referred to the ARCO Clean Fuels Projects EIR (SCAQMD 1993; SCH. No. 92091041) and the ARCO Polypropylene Project EIR (SCAQMD 1997; SCH No. 97011049) for general background information on LAR. In addition, the reader is referred to the SCAQMD's 1997 Air Quality Management Plan (AQMP) (SCAQMD 1996) for information specifically related to air quality in the South Coast Air Basin. Copies of these documents may be obtained by calling the SCAQMD's Public Information Center at (909) 396-2550.

3.1 Air Quality

The current air quality settings at the ARCO LAR, Marine Terminal 2, Hathaway Terminal, East Hynes Terminal, Vinvale Terminal, Carson Terminal, and Colton Terminal, and their surrounding areas are presented in this section.

3.1.1 Regional Climate

LAR and the six terminals are located within the SCAQMD's jurisdiction (referred to hereafter as the District). The District consists of the four-county South Coast Air Basin (Basin) (including Orange County and the non-desert portions of Los Angeles, Riverside, and San Bernardino counties), the Riverside County portions of the Salton Sea Air Basin (SSAB), and the Mojave Desert Air Basin (MDAB). The Basin, which is a subarea of the District, is bounded by the Pacific Ocean to the west and the San Gabriel, San Bernardino, and San Jacinto mountains to the north and east. The Basin includes all of Orange County and the non-desert portions of Los Angeles, Riverside, and San Bernardino counties. The Riverside County portions of the SSAB and MDAB are bounded by the San Jacinto Mountains in the west and spans eastward to the Palo Verde Valley. The federal nonattainment area (known as the Coachella-San Jacinto Planning Area) is a subregion of Riverside County and the SSAB that is bounded by the San Jacinto Mountains to the west and the eastern boundary of the Coachella Valley to the east (Figure 3.1-1).

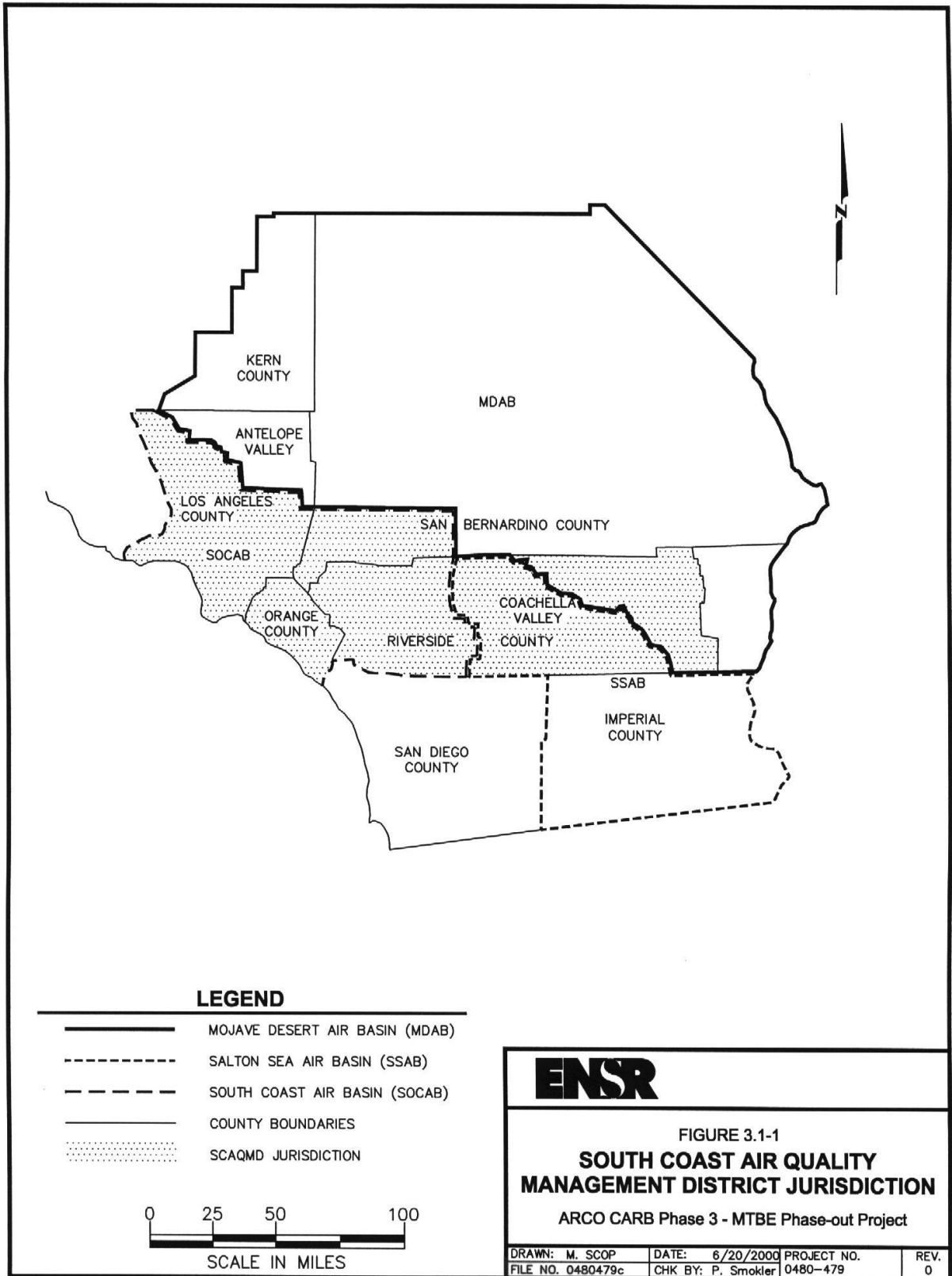

The area in the vicinity of the LAR, Marine Terminal 2, Hathaway Terminal and Carson Terminal is dominated by a semi-permanent, subtropical, Pacific high-pressure system. Generally mild, the climate is tempered by cool sea breezes, but may be infrequently interrupted by periods of extremely hot weather, passing winter storms, or Santa Ana winds. The East Hynes, Vinvale and Colton Terminals are located somewhat further inland where the temperature is generally higher and the relative humidity lower than along the coast.

3.1.2 Meteorology of the Project Vicinity

The LAR, Marine Terminal 2, Hathaway Terminal, and Carson Terminal are located in an area where the topography is relatively flat (the Hathaway Terminal is located on the northeast slope of Signal Hill) with the Palos Verdes hills to the southwest and the Pacific Ocean to the south. Because of the close proximity of the ocean, winters are seldom cold, frost is rare, and minimum temperatures average around 45°F. Spring days may be cloudy because of the presence of high fog. Summers in the area are warmer than along the immediate coast, with peak temperatures averaging near 80°F. Rainfall averages about 10 inches a year, falling almost entirely from late October to early April. To determine the historical meteorological profile of the project area, temperature (mean, maximum, and minimum) and precipitation data from the Long Beach airport are used. Table 3.1-1 presents the temperature and precipitation data.

**Table 3.1-1
Average Monthly Temperatures and Precipitation for Long Beach, CA, 1941-1978**

Month	Long Beach		
	Mean Monthly Temperatures		Total Precipitation (inches)
	Maximum (°F)	Minimum (°F)	
January	65	44	2.14
February	66	46	2.18
March	67	48	1.53
April	70	51	0.76
May	73	55	0.14
June	76	58	0.04
July	81	62	Trace
August	82	63	0.09
September	81	61	0.16
October	77	56	0.15
November	72	50	1.43
December	67	43	1.65
Absolute extreme temperatures	111	21	10.27
Reference: Weather of U.S. Cities (Gale 1981)			

The East Hynes, Vinvale and Colton Terminals are located further inland. The East Hynes and Vinvale Terminals are near the Los Angeles Civic Center where average daily temperature ranges are about 30° in the summer and 25° in the winter. Minimum temperatures average around 47°F and peak temperatures average near 84°F. Rainfall averages about 15 inches a year, falling almost entirely between November and March. These data are detailed in Table 3.1-2.

**Table 3.1-2
Average Monthly Temperatures and Precipitation for
Los Angeles Civic Center, CA, 1941-1970**

Month	Los Angeles Civic Center		
	Mean Monthly Temperatures		Total Precipitation (inches)
	Maximum (°F)	Minimum (°F)	
January	67	47	3.00
February	68	49	2.77
March	69	50	2.19
April	71	53	1.27
May	73	56	0.13
June	77	60	0.03
July	83	64	0.00
August	84	64	0.04
September	83	63	0.17
October	78	59	0.27
November	73	52	2.02
December	68	48	2.18
Absolute extreme temperatures	110	28	14.05
Reference: Weather of U.S. Cities (Gale 1981)			

The Colton Terminal is located near the San Bernardino meteorological site. The average minimum and maximum temperatures are 37°F and 97°F, respectively. Average annual rainfall in this area is nearly seventeen inches. Table 3.1-3 presents the average temperature and precipitation information based on 64 and 91 years of data, respectively.

**Table 3.1-3
Monthly Temperatures and Precipitation for San Bernardino, CA**

Month	San Bernardino		
	Mean Monthly Temperatures		Total Precipitation (inches)
	Maximum (°F)	Minimum (°F)	
January	66	37	5.32
February	68	40	5.25
March	71	42	4.11
April	75	45	2.41
May	80	49	0.44
June	88	53	0.08
July	97	57	0.03
August	96	57	0.08
September	93	54	0.38
October	83	48	1.18
November	76	41	2.18
December	68	38	4.94
Absolute extreme temperatures	116	17	16.57
Reference: A Climatological/Air Quality Profile (SCAQMD 1980)			

The locations of the three meteorological monitoring stations, Long Beach, Los Angeles Civic Center, and San Bernardino are shown relative to the project sites in Figure 3.1-2.

Seasonal and diurnal wind regimes affect the horizontal transport of air in the vicinity of the coastal project locations. Diurnal sea breeze-drainage flow typically dominates the local wind pattern with the onshore winds split by the Palos Verdes hills unless the marine layer is very deep. Typical winter and summer season wind patterns for morning and afternoon for the Basin are shown in Figure 3.1-3. An annual wind rose for Long Beach, representative of the LAR, Marine Terminal 2, Carson Terminal and Hathaway Terminal, is shown in Figure 3.1-4. An annual wind rose for Compton representative of the East Hynes Terminal is shown in Figure 3.1-5. An annual wind rose for Lynwood representative of the Vinvale Terminal is shown in Figure 3.1-6. An annual wind rose for Riverside representative of the Colton terminal is shown in Figure 3.1-7.

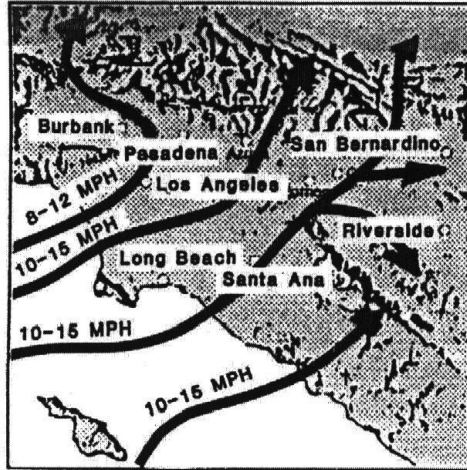

Typical Summer Daytime Ocean Winds
(noon to 7:00 pm)

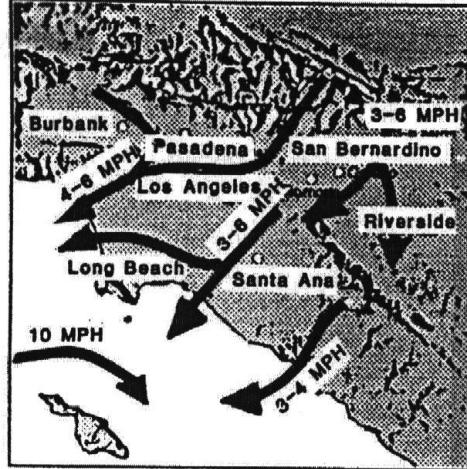

Typical Summer Night Drainage Winds
(midnight to 5:00 am)

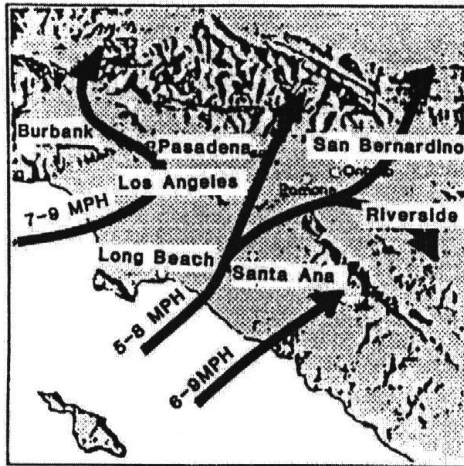

Typical Winter Daytime Ocean Winds
(noon to 7:00 pm)

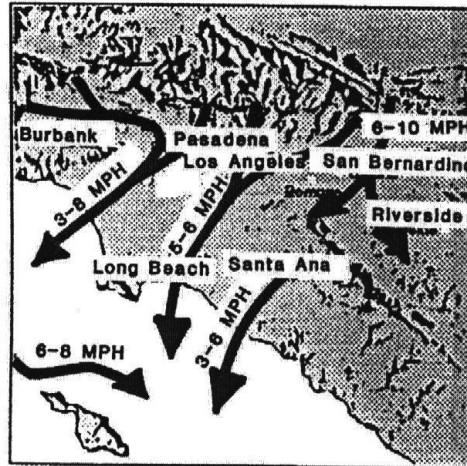

Typical Winter Night Drainage Winds
(midnight to 5:00 am)

ENSR

FIGURE 3.1-3
Dominant Wind Patterns in the Basin

ARCO CARB Phase 3 - MTBE Phase-out Project

Reference: AQMD CEQA Air Quality Handbook, November 1993

Drawn by: M. Scop	Date: 6/29/2000	Project number: 0480-479	REV: 0
Figure Name: 0480479E.dsf	Checked by: P. Smokler		

Long Beach 1981

January 1-December 31; Midnight-11 PM

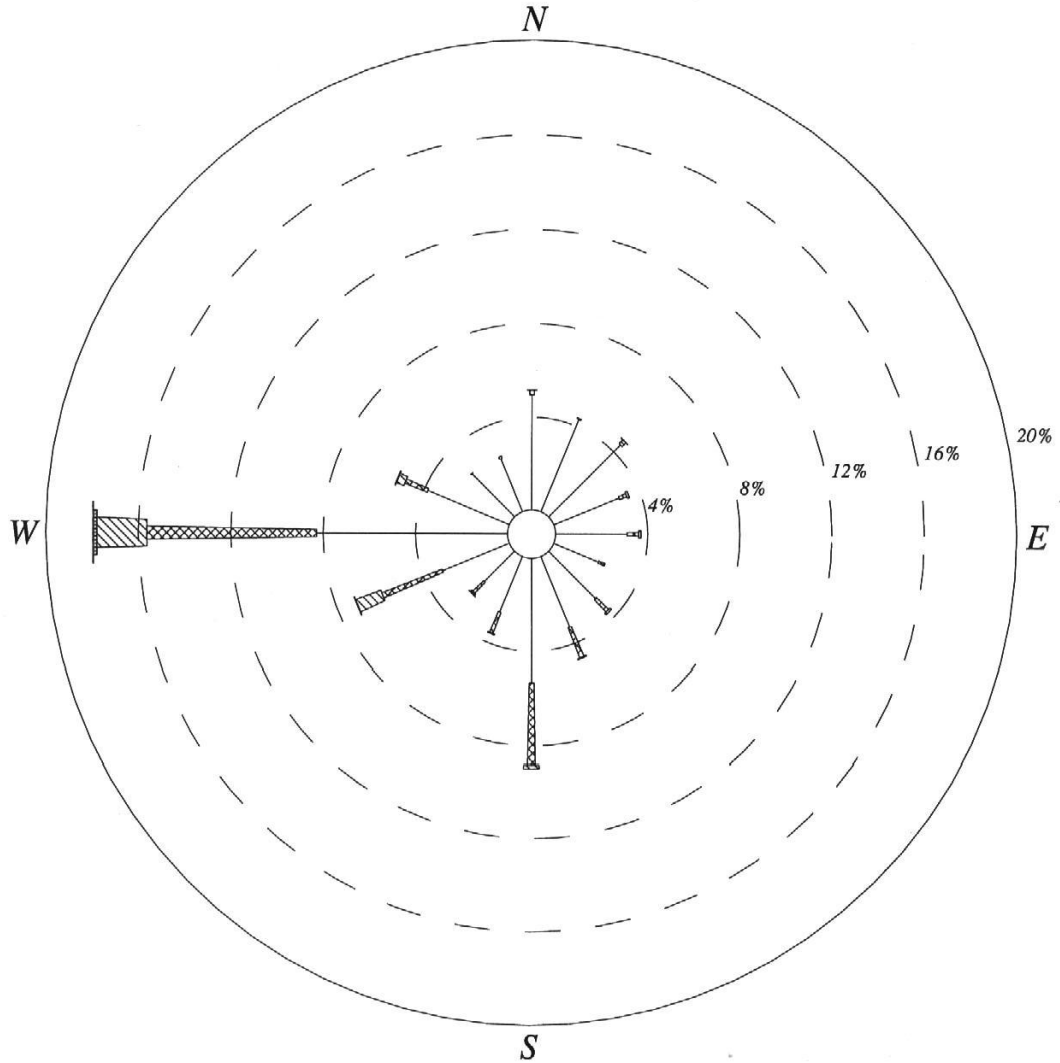

CALM WINDS 16.93%

WIND SPEED (KNOTS)

NOTE: Frequencies indicate direction from which the wind is blowing.

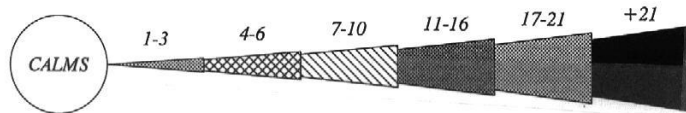
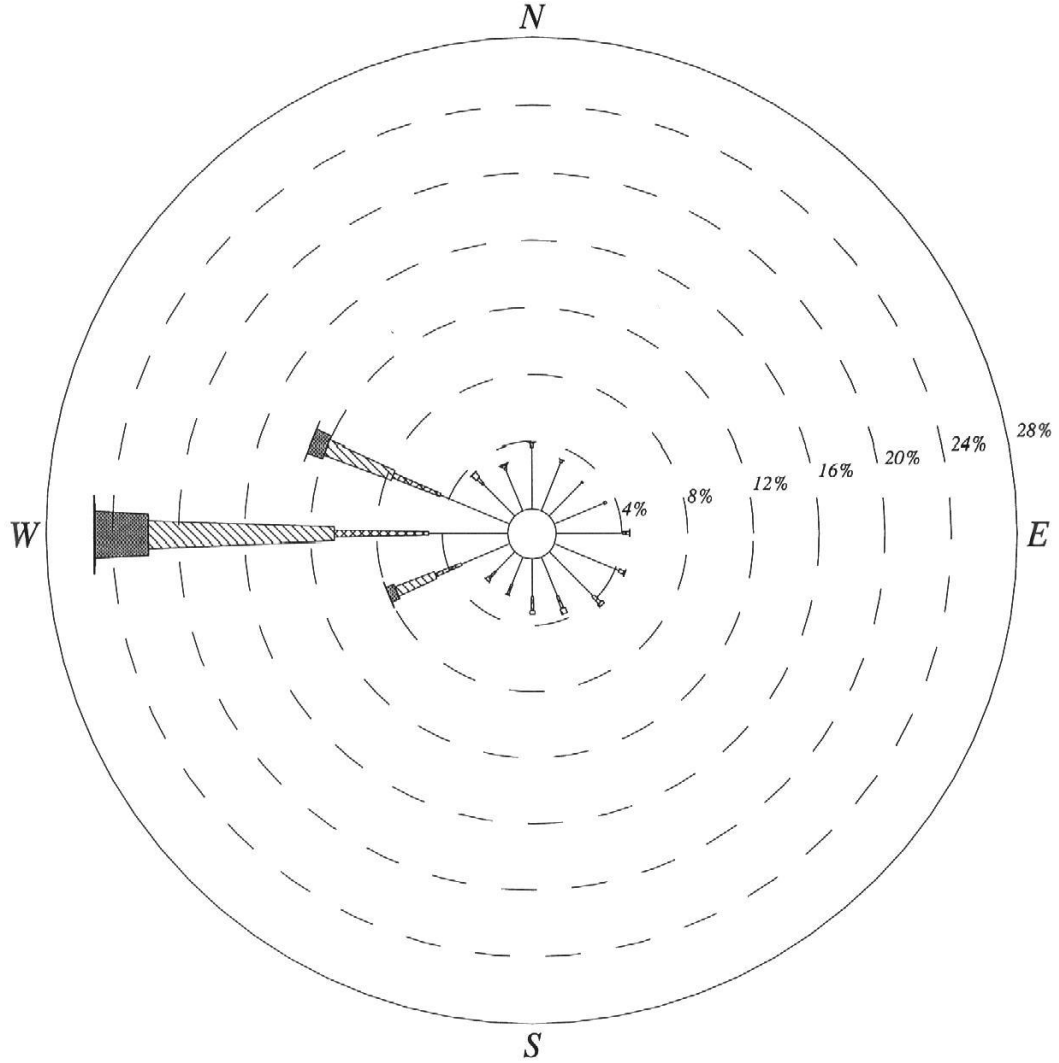

Figure 3.1-4 – Long Beach Station

Compton 1981

January 1-December 31; Midnight-11 PM



CALM WINDS 7.79%

WIND SPEED (KNOTS)

NOTE: Frequencies indicate direction from which the wind is blowing.

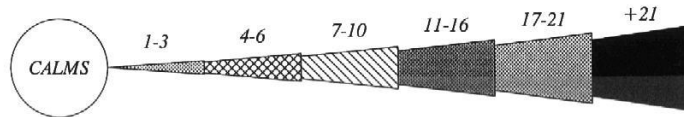

Figure 3.1-5 – Compton Station

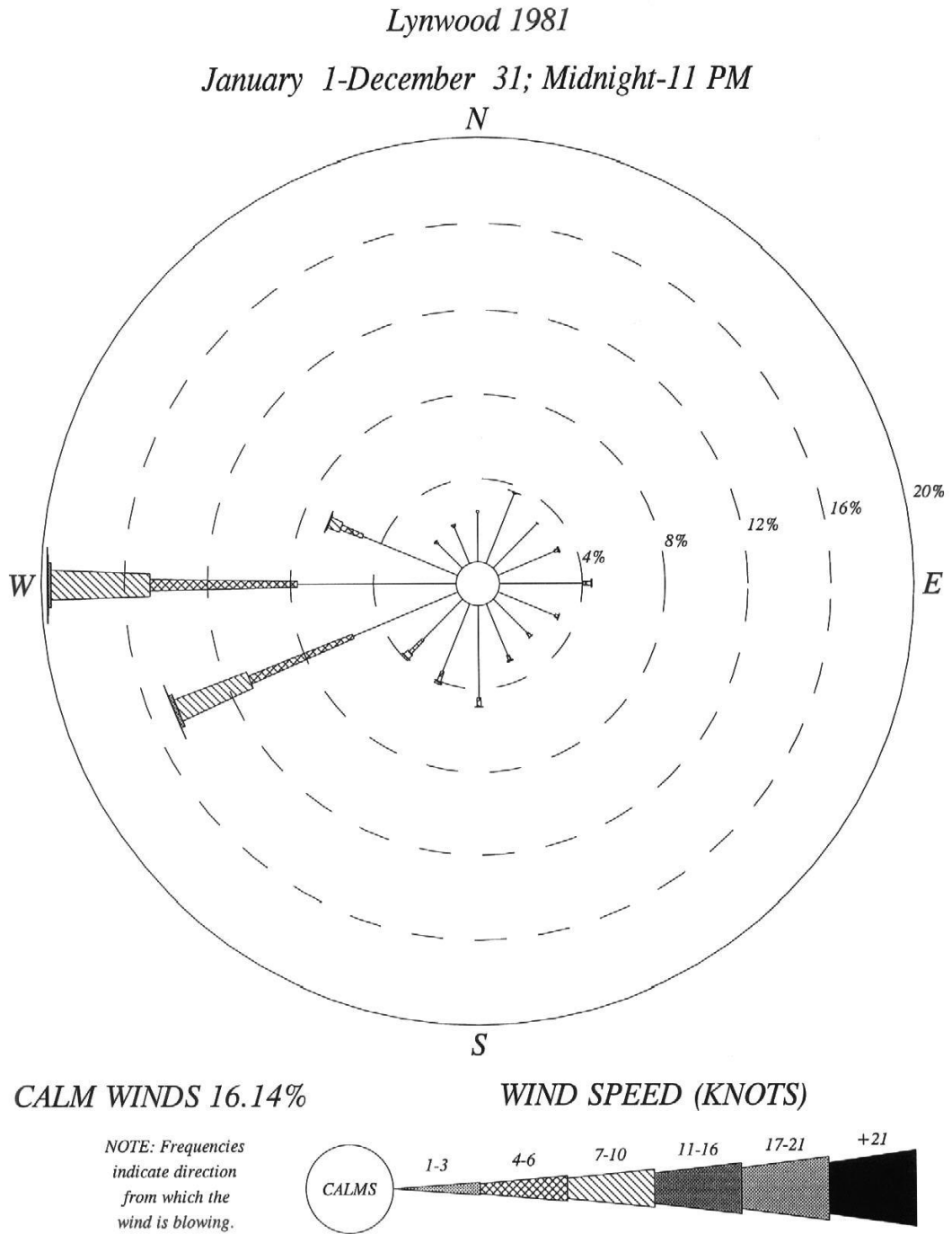
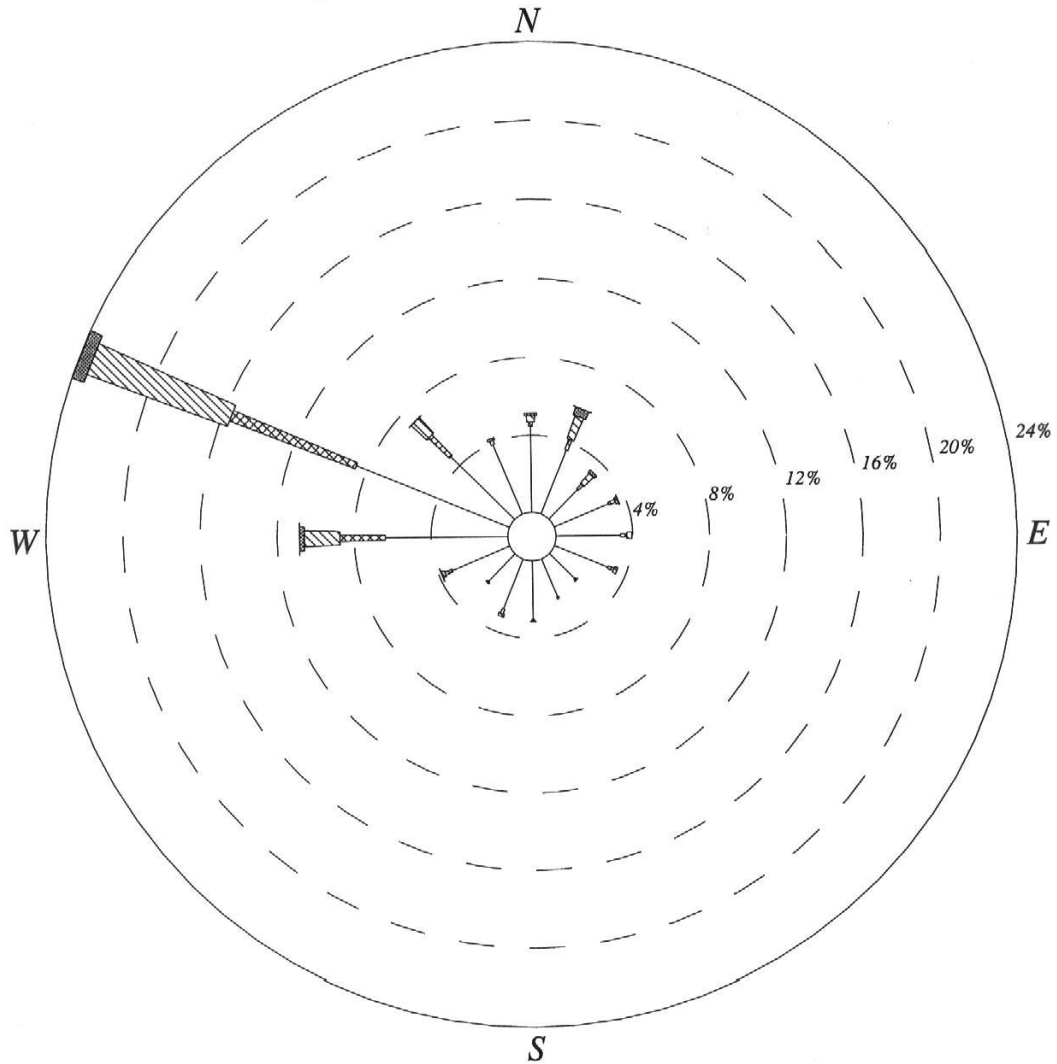

Figure 3.1-6 – Lynwood Station

Riverside 1981

January 1-December 31; Midnight-11 PM



CALM WINDS 11.75%

WIND SPEED (KNOTS)

NOTE: Frequencies indicate direction from which the wind is blowing.

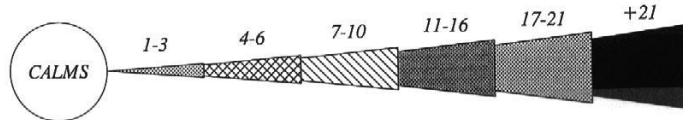

Figure 3.1-7 – Riverside Station

Normally, the temperature of the atmosphere decreases with altitude. However, when the temperature of the atmosphere increases with altitude, this phenomenon is termed an inversion. This inversion condition can exist at the surface or at any height above the ground. The height of the base of the inversion often corresponds to the mixing height. Usually, the mixing height increases throughout the morning and early afternoon because the sun warms the ground, which in turn warms the adjacent air. As this warm air rises, it erodes and raises the base of the inversion layer. If enough surface heating takes place, the inversion layer will break and the surface air layers can mix upward essentially without limit.

The District is characterized by frequent occurrence of strong elevated inversions. These inversions, created by atmospheric subsidence, severely limit vertical mixing, especially in the late morning and early afternoon.

3.1.3 Existing Air Quality

Air quality is determined primarily by the type and amount of contaminants emitted into the atmosphere, the size and topography of the air basin, and the meteorological conditions. The District has low mixing heights and light winds, which are conducive to the accumulation of air pollutants. Pollutants that impact air quality are generally divided into two categories: criteria pollutants (those for which health-based ambient standards have been set) and toxic air contaminants (those that cause cancer or have adverse human health effects other than cancer).

3.1.3.1 Criteria Pollutants

The determination of whether a region's air quality is healthful or unhealthful is determined by comparing contaminant levels in ambient air samples to national and state standards. These standards are set by the EPA and CARB at levels to protect public health and welfare with an adequate margin of safety. National Ambient Air Quality Standards (NAAQS) were first authorized by the federal Clean Air Act of 1970. California Ambient Air Quality Standards (CAAQS) were authorized by the state legislature in 1967. Air quality of a region is considered to be in attainment of the standards (or healthful) if the measured ambient air pollutant levels are continuously equal to or less than the CAAQS and NAAQS and do not exceed the CAAQS and NAAQS more than once in any consecutive three-year period.

Health-based air quality standards have been established by California and the federal government for the following criteria air pollutants: ozone (O₃), carbon monoxide (CO), nitrogen dioxide (NO₂), particulate matter less than 10 microns in diameter (PM₁₀), sulfur dioxide (SO₂), and lead. These standards were established to protect sensitive receptors from adverse health impacts due to exposure to air pollution. CAAQS are more stringent than the federal standards, and in the case of PM₁₀ and SO₂, are much more stringent. California has also established standards for sulfate, visibility, hydrogen sulfide, and vinyl chloride. However, hydrogen sulfide and vinyl chloride are currently not monitored in the District because these contaminants are not

seen as a significant air quality problem. CAAQS and NAAQS for each of these pollutants and their effects on health are summarized in Table 3.1-4.

Figure 3.1-8 identifies the locations of ambient air monitoring stations in the South Coast Air Basin. Four years of data (1996-1999) are summarized in Tables 3.1-5, 3.1-6, and 3.1-7 for the stations located in the vicinity of the project locations.

**Table 3.1-4
Ambient Air Quality Standards**

Air Pollutant	State Standard	Federal Primary Standard	Most Relevant Effects
	Concentration/ Averaging Time	Concentration/ Averaging Time	
Ozone	0.09 ppm, 1-hr. avg.	0.12 ppm, 1-hr avg.	(a) Short-term exposures: (1) Pulmonary function decrements and localized lung edema in humans and animals (2) Risk to public health implied by alterations in pulmonary morphology and host defense in animals; (b) Long-term exposures: Risk to public health implied by altered connective tissue metabolism and altered pulmonary morphology in animals after long-term exposures and pulmonary function decrements in chronically exposed humans; (c) Vegetation damage; (d) Property damage
Carbon Monoxide	9.0 ppm, 8-hr avg. 20 ppm, 1-hr avg.	9 ppm, 8-hr avg. 35 ppm, 1-hr avg.	(a) Aggravation of angina pectoris and other aspects of coronary heart disease; (b) Decreased exercise tolerance in persons with peripheral vascular disease and lung disease; (c) Impairment of central nervous system functions; (d) Possible increased risk to fetuses

**Table 3.1-4 (Cont.)
Ambient Air Quality Standards**

Air Pollutant	State Standard	Federal Primary Standard	Most Relevant Effects
	Concentration/ Averaging Time	Concentration/ Averaging Time	
Nitrogen Dioxide	0.25 ppm, 1-hr avg.	0.053 ppm, ann. Avg.	(a) Potential to aggravate chronic respiratory disease and respiratory symptoms in sensitive groups; (b) Risk to public health implied by pulmonary and extra-pulmonary biochemical and cellular changes and pulmonary structural changes; (c) Contribution to atmospheric discoloration
Sulfur Dioxide	0.04 ppm, 24-hr avg. 0.25 ppm, 1-hr. avg.	0.03 ppm, ann. Avg. 0.14 ppm, 24-hr avg.	(a) Bronchoconstriction accompanied by symptoms which may include wheezing, shortness of breath and chest tightness, during exercise or physical activity in persons with asthma
Suspended Particulate Matter (PM ₁₀)	30 µg/m ³ , ann. Geometric mean 50 µg/m ³ , 24-hr average	50 µg/m ³ , annual arithmetic mean 150 µg/m ³ , 24-hr avg.	(a) Excess deaths from short-term exposures and exacerbation of symptoms in sensitive patients with respiratory disease; (b) Excess seasonal declines in pulmonary function, especially in children
Sulfates	25 µg/m ³ , 24-hr avg.		(a) Decrease in ventilatory function; (b) Aggravation of asthmatic symptoms; (c) Aggravation of cardio-pulmonary disease; (d) Vegetation damage; (e) Degradation of visibility; (f) Property damage
Lead	1.5 µg/m ³ , 30-day avg.	1.5 µg/m ³ , calendar quarter	(a) Increased body burden; (b) Impairment of blood formation and nerve conduction
Visibility-Reducing Particles	In sufficient amount to reduce the visual range to less than 10 miles at relative humidity less than 70%, 8-hour average (10am - 6pm)		Visibility impairment on days when relative humidity is less than 70 percent

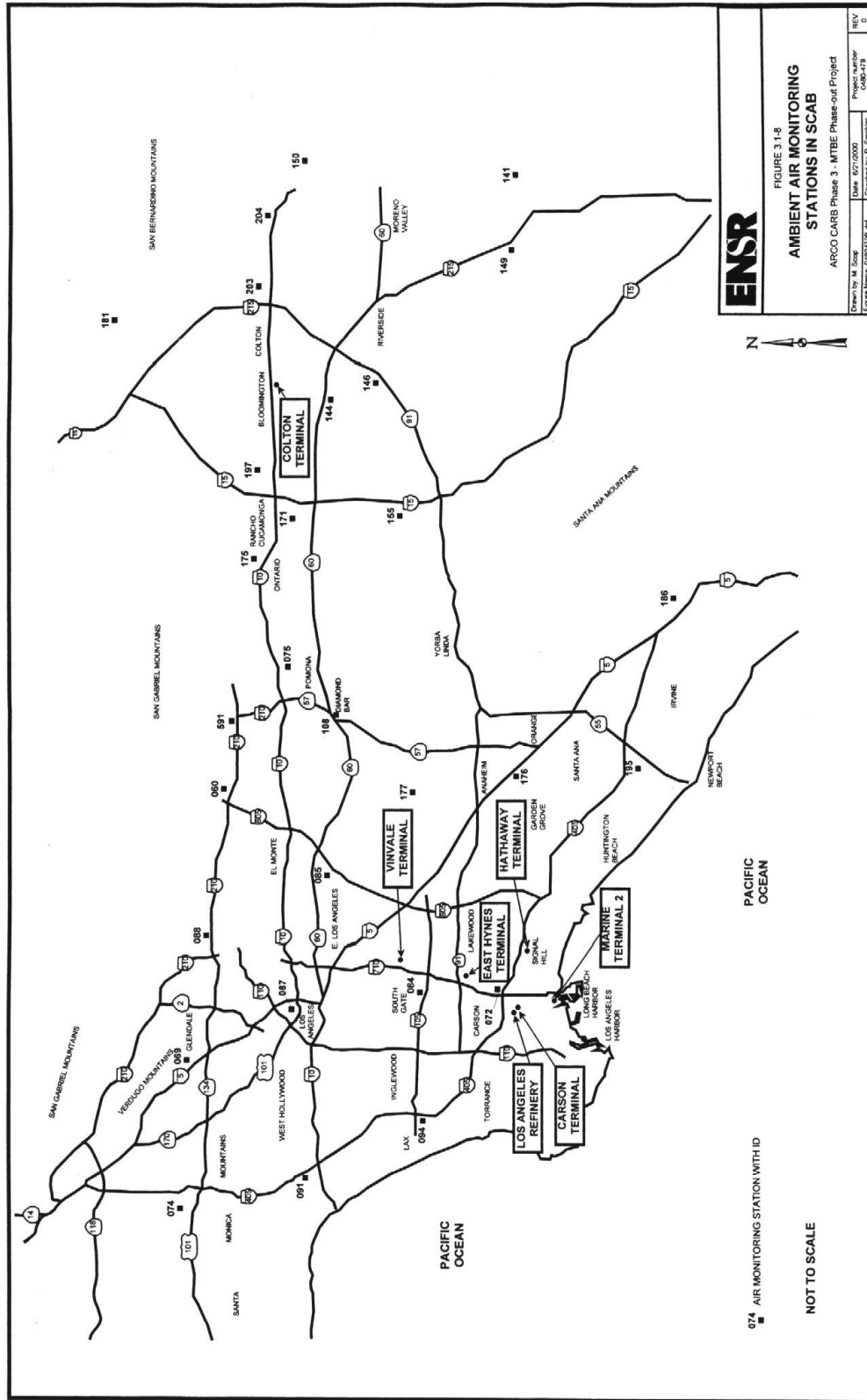

**Table 3.1-5
Background Air Quality Data for the Long Beach Monitoring Station (ID No. 072)
(1996-1999)**

Constituent	Maximum Observed Concentration (in ppm, unless otherwise noted) (No. of Standard Exceedances - most restrictive)					
	State Standard	Federal Standard	1996	1997	1998	1999
<u>Carbon monoxide</u> 1-hour 8-hour	20.0 ppm 9.0 ppm	35.0 ppm 9.5 ppm	10 (0 days) 6.9 (0 days)	9 (0 days) 6.7 (0 days)	8 (0 days) 6.6 (0 days)	7 (0 days) 5.4 (0 days)
<u>Ozone</u> 1-hour	0.09 ppm	0.12 ppm	0.11 (5 days)	0.10 (1 day)	0.12 (2 days)	0.13 (3 days)
<u>Nitrogen dioxide</u> 1-hour Annual	0.25 ppm ---	----- 0.053 ppm	0.17 (0 days) 0.034 ppm	0.20 (0 days) 0.033 ppm	0.16 (0 days) 0.034 ppm	0.15 (0 days) 0.034 ppm
<u>Sulfur dioxide</u> 1-hour 24-hour Annual	0.25 ppm 0.04 ppm ---	----- 0.14 ppm 0.03 ppm	0.04 (0 days) 0.013 (0 days) 0.003 ppm	0.04 (0 days) 0.011 (0 days) 0.002 ppm	0.08 (0 days) 0.013 (0 days) 0.002 ppm	0.05 (0 days) 0.011 (0 days) 0.003 ppm
<u>PM₁₀</u> 24-hour Annual Mean: Geometric Arithmetic	50 :g/m ³ 30 :g/m ³ ---	150 :g/m ³ ----- 50 :g/m ³	113 :g/m ³ (7 days) 30.8 :g/m ³ 35.3 :g/m ³	87 :g/m ³ (10 days) 38.2 :g/m ³ 40.5 :g/m ³	69 :g/m ³ (6 days) 29.2 :g/m ³ 32.3 :g/m ³	79 :g/m ³ (13 days) 36.4 :g/m ³ 38.9 :g/m ³
<u>Lead</u> 30-day Calendar Quarter	1.5 :g/m ³ ---	----- 1.5 :g/m ³	0.08 :g/m ³ (0 mos.) 0.08 :g/m ³ (0 qtrs.)	0.05 :g/m ³ (0 mos.) 0.03 :g/m ³ (0 qtrs.)	0.07 :g/m ³ (0 mos.) 0.04 :g/m ³ (0 qtrs.)	0.06 :g/m ³ (0 mos.) 0.05 :g/m ³ (0 qtrs.)
<u>Sulfates</u> 24-hours	25 :g/m ³	---	19.9 :g/m ³ (0 days)	11.4 :g/m ³ (0 days)	14.5 :g/m ³ (0 days)	13.7 :g/m ³ (0 days)
* = Incomplete record of data; may not be representative. PM ₁₀ and sulfate only monitored every 6 days. :g/m ³ = micrograms per cubic meter. Reference: CARB Air Quality Data Annual Summaries 1996-1999; SCAQMD Air Quality Data Annual Summaries 1996-1999.						

Table 3.1-6
Background Air Quality Data for the South Central Los Angeles County
Monitoring Station (ID No. 084)
(1996-1999)

Constituent	Maximum Observed Concentration (in ppm, unless otherwise noted) (No. of Standard Exceedances - most restrictive)					
	State Standard	Federal Standard	1996	1997	1998	1999
<u>Carbon monoxide</u>						
1-hour	20.0 ppm	35.0 ppm	22 (2 days)	19 (0 days)	17 (10 days)	19 (10 days)
8-hour	9.0 ppm	9.5 ppm	17.3 (24 days)	17.0 (18 days)	13.4 (11 days)	11.0 (10 days)
<u>Ozone</u>						
1-hour	0.09 ppm	0.12 ppm	0.10 (1 day)	0.08 (0 days)	0.09 (0 days)	0.12 (1 day)
<u>Nitrogen dioxide</u>						
1-hour	0.25 ppm	---	0.25 (0 days)	0.20 (0 days)	0.16 (0 days)	0.18 (0 days)
Annual	---	0.053 ppm	0.0412 ppm	0.0428 ppm	0.0393 ppm	0.0428 ppm
<u>Sulfur dioxide</u>						
1-hour		---				
24-hour	0.25 ppm	0.14 ppm	No data	No data	No data	No data
Annual	0.04 ppm	0.03 ppm				

<u>PM₁₀</u>						
24-hour	50 :g/m ³	150 :g/m ³				
Annual Mean:			No data	No data	No data	No data
Geometric	30 :g/m ³	---				
Arithmetic	---	50 :g/m ³				
<u>Lead</u>						
30-day	1.5 :g/m ³	---	0.09* :g/m ³ (0 mos.)	0.07* :g/m ³ (0 mos.)	0.07 :g/m ³ (0 mos.)	0.17 :g/m ³ (0 mos.)
Calendar Quarter	---	1.5 :g/m ³	0.05* :g/m ³ (0 qtrs.)	0.07* :g/m ³ (0 qtrs.)	0.04 :g/m ³ (0 qtrs.)	0.09 :g/m ³ (0 qtrs.)
<u>Sulfates</u>						
24-hours	25 :g/m ³	---	16.0 :g/m ³ (0 days)	11.4* :g/m ³ (0 days)	12.0 :g/m ³ (0 days)	15.6 :g/m ³ (0 days)
* = Incomplete record of data; may not be representative. PM ₁₀ and sulfate only monitored every 6 days. :g/m ³ = micrograms per cubic meter. Reference: CARB Air Quality Data Annual Summaries 1995-1998; SCAQMD Air Quality Data Annual Summaries 1996-1999.						

**Table 3.1-7
Background Air Quality Data for the Central San Bernardino Valley Monitoring Station
(ID No. 203) - (1996-1999)**

Constituent	Maximum Observed Concentration (in ppm, unless otherwise noted) (No. of Standard Exceedances - most restrictive)					
	State Standard	Federal Standard	1996	1997	1998	1999
<u>Carbon monoxide</u>						
1-hour	20.0 ppm	35.0 ppm	6 (0 days)	8* (0 days)	6 (0 days)	5 (0 days)
8-hour	9.0 ppm	9.5 ppm	4.6 (0 days)	6* (0 days)	4.6 (0 days)	4.0 (0 days)
<u>Ozone</u>						
1-hour	0.09 ppm	0.12 ppm	0.24 (113 days)	0.20 (102 days)	0.21 (65 days)	0.16 (45 days)
<u>Nitrogen dioxide</u>						
1-hour	0.25 ppm	---	0.15 (0 days)	0.14 (0 days)	0.11 (0 days)	0.14 (0 days)
Annual	---	0.053 ppm	0.0384 ppm	0.0353 ppm	0.0339 ppm	0.0358 ppm
<u>Sulfur dioxide</u>						
1-hour	0.25 ppm	---	No data	No data	No data	No data
24-hour	0.04 ppm	0.14 ppm				
Annual	---	0.03 ppm				
<u>PM₁₀</u>						
24-hour	50 :g/m ³	150 :g/m ³	136 :g/m ³ (35 days)	108 :g/m ³ (27 days)	114 :g/m ³ (22 days)	134 :g/m ³ (33 days)
Annual Mean:						
Geometric	30 :g/m ³	---	45.9 :g/m ³	45.6 :g/m ³	39.3 :g/m ³	56.5 :g/m ³
Arithmetic	---	50 :g/m ³	52.9:g/m ³	51.4:g/m ³	46.3 :g/m ³	50.6 :g/m ³
<u>Lead</u>						
30-day	1.5 :g/m ³	---	0.06 :g/m ³ (0 mos.)	0.04* :g/m ³ (0 mos.)	0.05 :g/m ³ (0 mos.)	0.07 :g/m ³ (0 mos.)
Calendar Quarter	---	1.5 :g/m ³	0.04 :g/m ³ (0 qtrs.)	0.04* :g/m ³ (0 qtrs.)	0.03 :g/m ³ (0 qtrs.)	0.05 :g/m ³ (0 qtrs.)
<u>Sulfates</u>						
24-hours	25 :g/m ³	---	11.2 :g/m ³ (0 days)	9.1* :g/m ³ (0 days)	11.5 :g/m ³ (0 days)	10.9 :g/m ³ (0 days)
* = Incomplete record of data; may not be representative. PM ₁₀ and sulfate only monitored every 6 days. :g/m ³ = micrograms per cubic meter. Reference: CARB Air Quality Data Annual Summaries 1995-1998; SCAQMD Air Quality Data Annual Summaries 1996-1999.						

The LAR, Marine Terminal 2, Hathaway Terminal, East Hynes and Carson Terminal are located within the SCAQMD Long Beach monitoring area. Recent background air quality data for criteria pollutants for the Long Beach monitoring station are presented in Table 3.1-5. Ambient air quality was compared to the most stringent of either the CAAQS or NAAQS, which was the CAAQS in all

cases. These monitored data indicate the Long Beach area is in compliance with the CO, NO₂, SO₂, sulfate, and lead for both the CAAQS and NAAQS.

State O₃ and PM₁₀ air quality standards were exceeded at the Long Beach air monitoring station on several days each year. The national PM₁₀ standards were met in all years. The maximum O₃ concentrations observed have remained relatively the same, whereas the maximum concentration of PM₁₀ observed has decreased at this site from 113 µg/m³ to 79 µg/m³. The number of days with exceedances for O₃ and PM₁₀ have remained relatively the same for the four-year period.

Neither the state nor the national 1-hour and 8-hour CO standards were exceeded during this four-year period. For NO₂, the maximum measured concentrations each year were less than the 0.25 ppm one-hour state standard and the annual national standard. For SO₂ and lead, measured concentrations were well below both the state and federal standards. The maximum sulfate concentrations were below the state 24-hour standard each year.

The Vinvale Terminal is located within the South Central Los Angeles County monitoring station area. Recent background air quality data for criteria pollutants are presented in Table 3.1-6. Ambient air quality was compared to the most stringent of either the CAAQS or NAAQS, which was the CAAQS in all cases. These monitored data indicate that this area is in compliance with the NO₂, sulfate, and lead for both the CAAQS and NAAQS.

The state O₃ air quality standard was exceeded at the South Central Los Angeles County air monitoring station on one day in 1996 and one day in 1999. The national O₃ standard was attained in all years. Data were not available for SO₂ and PM₁₀ at this station for these years.

The state 1-hour CO standard was exceeded twenty-two times during this four-year period. Both the state and federal 8-hour standards were exceeded for CO. For NO₂, the maximum measured concentration each year was less than or equal to the 0.25 ppm one-hour state standard and the annual national standard. For lead, measured concentrations were well below both the state and federal standards when data were available. The maximum sulfate concentrations were below the state 24-hour standard each year.

The Colton Terminal is located within the Central San Bernardino Valley monitoring station area. Recent background air quality data for criteria pollutants are presented in Table 3.1-7. Ambient air quality was compared to the most stringent of either the CAAQS or NAAQS, which was the CAAQS in all cases. These monitored data indicate that this area is in compliance with the CO, NO₂, sulfate, and lead standards for both the CAAQS and NAAQS.

State O₃ and PM₁₀ air quality standards were exceeded at the Central San Bernardino Valley air monitoring station on several days each year. The number of days that the state O₃ standard was exceeded has dropped significantly, from 113 to 45 days, over this period and the maximum concentrations observed has dropped from 0.24 ppm to 0.16 ppm. Peak PM₁₀ concentrations and the number of observed exceedances of the standards have remained relatively the same over this period. Data were not available for SO₂ at this station for these years.

The state and federal 1-hour and 8-hour CO standards were not exceeded during this four-year period. For NO₂, the maximum measured concentrations each year were less than the 0.25 ppm one-hour state standard and the annual national standard. The maximum sulfate concentrations were below the state 24-hour standard each year. For lead, measured concentrations were determined to be well below the standards, when data was obtained.

In 1997, the USEPA promulgated a new national ambient air quality standard for ozone. However, a recent court decision has ordered that the USEPA cannot enforce the new standard until the USEPA provides adequate justification for the new standard. The USEPA is in the process of appealing the decision. Meanwhile CARB and local air districts continue to collect technical information in order to prepare for an eventual SIP to reduce unhealthy levels of ozone in areas violating the new federal standard. California has previously developed a SIP for the current ozone standard.

In 1997, the USEPA promulgated a new national ambient air quality standard for PM_{2.5}, particulate matter 2.5 microns or less in diameter. The PM_{2.5} standard complements existing national and state ambient air quality standards that target the full range of inhalable PM₁₀. However, a recent court decision has ordered that the USEPA cannot enforce the new standard until USEPA provides adequate justification for the new standard. USEPA is in the process of appealing the decision. Meanwhile, CARB and local air districts continue to collect technical information in order to prepare for an eventual SIP to reduce unhealthy levels of PM_{2.5} in areas violating the new federal standard. California has previously developed a SIP for the current PM₁₀ standard.

3.1.3.2 Toxic Air Contaminants

Cancer Risk

Health statistics show that one in four people will contract cancer over their lifetime, or 250,000 in a million, from all causes, including diet, genetic factors and lifestyle choices.

One of the primary health risks of concern due to exposure to toxic air contaminants (TACs) is the risk of contracting cancer. The carcinogenic potential of TACs is a particular public health concern because it is currently believed by many scientists that there is no "safe" level of exposure to carcinogens. Any exposure to a carcinogen poses some risk of causing cancer. It is currently estimated that about one in four deaths in the United States is attributable to cancer. About two percent of cancer deaths in the United States may be attributable to environmental pollution (Doll and Peto, 1981).

Noncancer Health Risks

Unlike carcinogens, for most noncarcinogens it is believed that there is a threshold level of exposure to the compound below which it will not pose a health risk. The California Environmental Protection Agency (CalEPA) and Office of Environmental Health Hazard Assessment (OEHHA) develop reference exposure levels (RELs) for TACs that are health-

conservative estimates of the levels of exposure at or below which health effects are not expected. The noncancer health risk due to exposure to a TAC is assessed by comparing the estimated level of exposure to the REL. The comparison is expressed as the ratio of the estimated exposure level to the REL, called the hazard index (HI).

Multiple Air Toxics Exposure Study II (MATES II) Study

The MATES II study, which is the most comprehensive study of urban toxic air pollution ever undertaken, shows that motor vehicles and other mobile sources of air pollution are the predominant source of cancer-causing air pollutants in the Basin. The SCAQMD's Governing Board directed staff to undertake the MATES II study as part of the agency's environmental justice initiatives (e.g., EJ Initiative #7) adopted in late 1997. A panel of scientists from universities, an environmental group, businesses and other government agencies helped design and guide the study. The study was aimed at determining the cancer risk from toxic air pollution throughout the area by monitoring toxics continually for one year at 10 monitoring sites. Another goal was to determine if there were any sites where TAC concentrations emitted by local industrial facilities were causing a disproportionate cancer burden on surrounding communities. To address this second goal, the SCAQMD monitored toxic pollutants at 14 sites for one month each with three mobile monitors. Monitoring platforms were placed in or near residential areas adjacent to clusters of facilities. Although no TAC hotspots were identified, models show that elevated levels can occur very close to facilities emitting TACs.

In the MATES II study, SCAQMD monitored more than 30 toxic air pollutants at 24 sites over a one-year period in 1999. The SCAQMD collected more than 4,500 air samples and together with the California Air Resources Board performed more than 45,000 separate laboratory analyses of these samples. A similar study known as MATES I was conducted in 1986 and 1987. In each study, SCAQMD calculated cancer risk assuming 70 years of continuous exposure to monitored levels of pollutants.

The MATES II study found that the average carcinogenic risk throughout the Basin is about 1,400 in one million ($1,400 \times 10^{-6}$). Mobile sources (e.g., cars, trucks, trains, ships, aircraft, etc.) represent the greatest contributors. As shown in Figure 3.1-9, about 70 percent of all risk is attributed to diesel particulate emissions; about 20 percent to other toxics associated with mobile sources (including benzene, butadiene, and formaldehyde); about 10 percent of all risk is attributed to stationary sources (which include industries and other certain businesses such as dry cleaners and chrome plating operations.)

3.1.4 Regional Emissions Inventory

The SCAQMD compiles emissions inventories for anthropogenic sources, i.e., those associated with human activity, and natural sources such as vegetation and wind erosion. SCAQMD's current emissions inventory for the District is summarized in Table 3.1-8. The emissions inventory for the anthropogenic inventory is made up of stationary sources (both point and area sources are

in this category) and mobile sources encompassing on-road and off-road mobile sources. On-road mobile sources include light-duty passenger vehicles; light-, medium-, and heavy-duty trucks; motorcycles, and urban buses. Off-road mobile sources include off-road vehicles, trains, ships, aircraft, and mobile equipment.

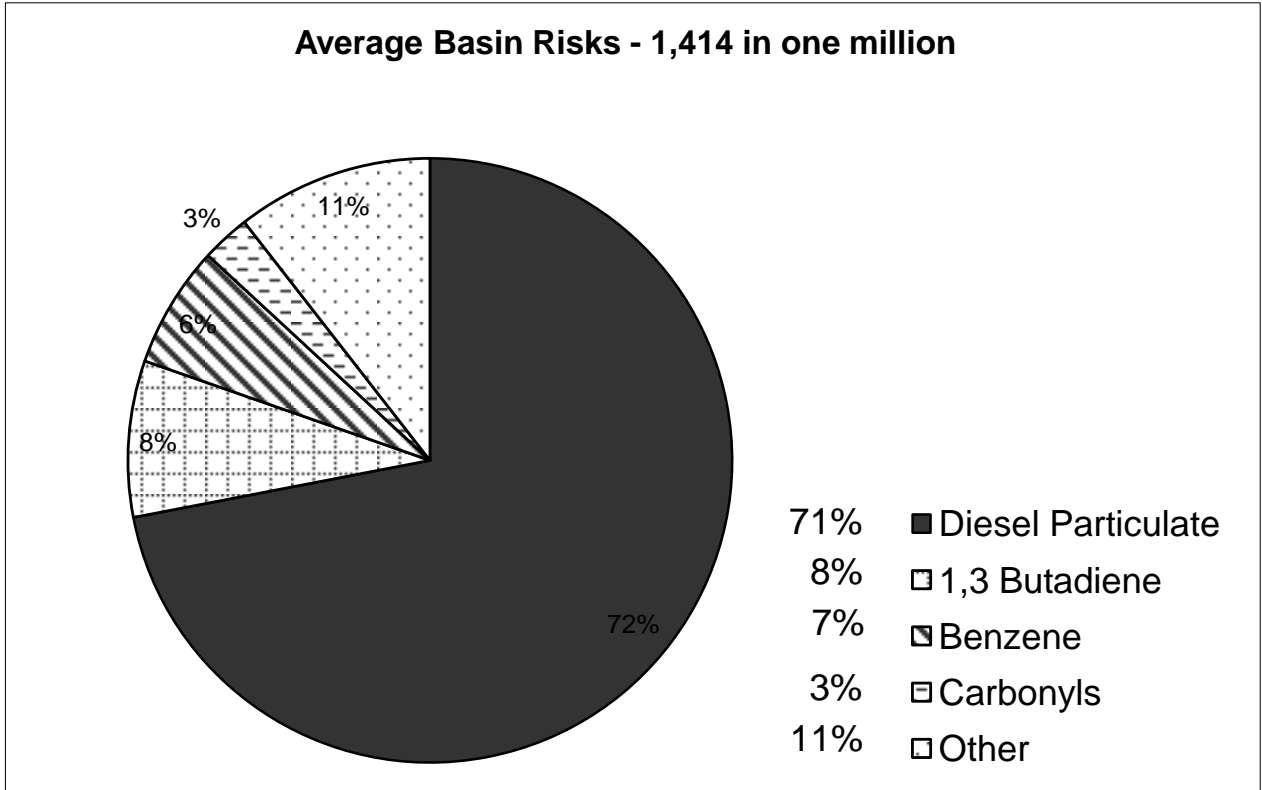

Figure 3.1.9 Major Pollutants Contributing To Cancer Risk In The South Coast Air Basin

**Table 3.1-8
Anthropogenic Sources of Criteria Pollutant Emissions
(ton/day, annual average)**

Source Category	NO _x	SO _x	CO	VOC	PM ₁₀
Stationary and area sources	155.49	23.12	98.90	461.73	387.32
Mobile sources (on- and off-road)	1,134.32	75.42	8,562.40	857.27	45.36

**Table 3.1-8
Anthropogenic Sources of Criteria Pollutant Emissions
(ton/day, annual average)**

Source Category	NO_x	SO_x	CO	VOC	PM₁₀
Total	1,289.81	98.54	8,661.30	1,319.00	432.68
Source: Appendix III, 1997 AQMP					

3.1.4.1 Criteria Pollutants Inventory

The SCAQMD emissions inventory includes District levels for the criteria air pollutants NO_x, CO, SO_x, PM₁₀, and VOC (a precursor of criteria air pollutants). Since O₃ is formed by photochemical reactions involving the precursors VOC and NO_x, it is not inventoried.

As shown in Table 3.1-8, mobile sources are the major contributors to emissions in the District, i.e., CO (99 percent), NO_x (88 percent), SO_x (77 percent), and VOC (65 percent). The presence of PM₁₀ in the atmosphere is mainly attributable to entrained road dust (10 percent).

Although the LAR is near unincorporated sections of the County of Los Angeles and the cities of Los Angeles and Long Beach, inventory data from the City of Carson is used to establish the emissions inventory of the area surrounding LAR. The Emissions Inventory for the City of Carson is based on 1987 information, which includes both stationary and mobile sources. This emission information is the most up-to-date data available for the City of Carson (Ketz, 1997). Stationary source emissions are generated primarily from industries in the area. Mobile source emissions are primarily generated by inter-city travel on the four freeways that cross the city. The project site is located close to three interstate freeways (Interstates 110, 405, and 710) whose traffic and resultant emissions affect the local area, including the vicinity of the project. As shown in Table 3.1-9, emissions from both mobile and stationary sources were projected to decline from 1987 levels by 1994 as a result of in-place mobile and stationary sources controls. Stationary source emissions also appear to be declining as a result of facility shutdowns and the transformation of the region from heavy industry/manufacturing to light industry and service companies.

**Table 3.1-9
Projected 1994 Emissions in the City of Carson (ton/day)**

Source	THC	VOC	NO_x	CO	SO_x	TSP
---------------	------------	------------	-----------------------	-----------	-----------------------	------------

Chapter 3 Setting

Fuel combustion	0.61	0.24	4.26	1.42	0.21	0.36
Waste burning	0.05	0.02	0.12	0.01	0.01	0.00
Solvent use	9.19	8.27	0.00	0.00	0.00	0.01
Petroleum process, storage, and transfer	5.85	2.62	0.25	0.23	1.32	0.07
Industrial processes	0.85	0.62	0.09	0.01	0.52	0.09
Miscellaneous process	0.17	0.12	0.00	0.05	0.00	0.00
TOTAL STATIONARY	16.72	11.89	4.72	1.72	2.06	0.53
On-road mobile	3.56	2.97	4.56	28.74	0.22	0.84
Off-road mobile	0.60	0.52	2.22	4.05	0.17	0.00
Source	THC	VOC	NO_x	CO	SO_x	TSP
TOTAL MOBILE	4.16	3.49	6.78	32.79	0.39	0.84
TOTAL ALL SOURCES	20.88	15.38	11.50	34.51	2.45	1.37
Source: SCAQMD 1993						
Reference: City of Carson Draft Background Report, City of Carson Air Quality Element, June 1992.						
CO	- Carbon monoxide	SO _x	- Sulfur oxides	THC	- Total hydrocarbons	
NO _x	- Nitrogen oxides	VOC	- Volatile organic compounds	TSP	- Total suspended particulates	

3.1.4.2 Toxic Pollutants Inventory

The data available for toxic emissions inventories are not nearly as complete as the data for criteria pollutants. Starting in 1989, industrial facilities have been required to compile toxic emissions inventories under the AB 2588 program. Companies subject to the program are required to report their toxic emissions to the SCAQMD, which is currently reviewing the reported toxics from these companies.

The SCAQMD's first toxic air pollutant emissions inventory was compiled for 30 TACs for the year 1982 for stationary sources only. This inventory was updated during the preparation of the first MATES study and updated again for the MATES II study. This is the most up-to-date inventory prepared by the SCAQMD. A summary of the 1998 toxics emissions inventory is presented in Table 3.1-10 which provides the estimated toxic emissions for selected compounds by source category.

Table 3.1-10
1998 Annual Average Day Toxic Emissions for the South Coast Air Basin (lbs/day)

Pollutant	On-Road	Off-Road	Point	AB2588	Area	Total
Acetaldehyde ^a	5485.8	5770.3	33.9	57.1	189.1	11536.2
Acetone	4945.8	4824.7	3543.5	531.4	23447.4	37292.8

Benzene	21945.5	6533.4	217.7	266.8	2495.4	31458.8
Butadiene [1,3]	4033.8	1566.1	6.7	2.0	151.3	5759.9
Carbon tetrachloride	0.0	0.0	8.8	1.8	0.0	10.6
Chloroform	0.0	0.0	0.0	35.5	0.0	35.5
Dichloroethane [1,1]	0.0	0.0	0.0	0.1	0.0	0.1
Dioxane [1,4]	0.0	0.0	0.0	105.0	0.0	105.0
Ethylene dibromide	0.0	0.0	0.0	0.2	0.0	0.2
Ethylene dichloride	0.0	0.0	4.9	17.6	0.0	22.5
Ethylene oxide	0.0	0.0	58.1	12.3	454.1	524.4
Formaldehyde ^a	16664.9	16499.3	521.6	674.7	1107.5	35468.0
Methyl Ethyl Ketone ^a	905.1	906.9	3240.2	385.9	14535.4	19973.5
Methylene chloride	0.0	0.0	1378.6	1673.6	9421.7	12473.9
MTBE	58428.9	2679.2	40.5	434.4	5473.7	67056.7
p-Dichlorobenzene	0.0	0.0	0.0	4.5	3735.6	3740.1
Perchloroethylene	0.0	0.0	4622.0	2249.1	22813.1	29684.2
Propylene oxide	0.0	0.0	0.0	22.3	0.0	22.3
Styrene	1114.8	287.1	447.0	3836.7	21.4	5707.0
Toluene	63187.6	11085.9	5689.6	3682.4	52246.7	135892.2
Trichloroethylene	0.0	0.0	1.1	58.0	2550.3	2609.3
Vinyl chloride	0.0	0.0	0.0	4.3	0.0	4.3
Arsenic	0.1	0.3	2.7	0.7	21.4	25.2
Cadmium	1.6	1.5	0.5	0.7	27.5	31.8
Chromium	2.4	2.3	3.9	2.2	302.2	313.0
Diesel particulate	23906.3	22386.3	0.0	5.4	815.3	47113.4
Elemental carbon ^b	27572.1	6690.3	702.8	0.0	16770.5	51735.7
Hexavalent chromium	0.4	0.4	0.3	1.0	0.1	2.2
Lead	0.7	0.9	1.9	24.5	1016.3	1044.3
Nickel	2.5	2.2	2.9	21.6	85.6	114.9
Organic carbon	16426.2	15381.8	0.0	0.0	108612.1	140420.2
Selenium	0.1	0.1	3.0	5.7	2.6	11.6
Silicon	68.6	67.6	167.2	0.0	248614.0	248917.4
Source: Final MATES II Study, SCAQMD (March 2000).						
^a Primarily emitted.						
^b Including elemental carbon from all sources, including diesel particulates.						

3.2 Hydrology/Water Quality

Water issues in the Los Angeles and Santa Ana Basins are complex and affect supply, demand and quality of water for domestic, commercial, industrial and agricultural use. Water impacts also include the quality and availability of water for the region's ecosystems. Elements of both the regional and local hydrologic environment are presented in this section.

3.2.1 Water Quality

Extensive urbanization in the area has resulted in significant alteration and deterioration of the natural hydrologic environment. Presently, surface runoff flows into a network of storm drains that empty into the conduits of the Dominguez Channel, the Los Angeles River, and the Santa Ana River. Due to extensive paving and surfacing of the land throughout the area, groundwater recharge by infiltration has steadily decreased while pumping has increased. This imbalance has likely contributed to the contamination of natural freshwater groundwater basins by saltwater intrusion.

3.2.1.1 Surface Water Quality

Los Angeles Refinery

Water quality objectives for the Dominguez Channel are established by the RWQCB in the Water Quality Control Plan, commonly known as the Basin Plan (RWQCB 1995). In the Basin Plan, the Dominguez Channel is designated as a tidal prism with the following beneficial uses: contact and non-contact water recreation, commercial and sport fisheries, preservation of rare and endangered species, migrating species or spawning grounds, marine habitat, and saline water habitat. The Basin Plan lists a number of water quality objectives applicable to the Dominguez Channel.

ARCO normally discharges treated sanitary sewage, wastewater, storm water, cooling tower blowdown, and groundwater to the LACSD sewer under Permit No. 543R-3. LACSD restricts the total allowable discharge to 6.0 million gallons per day (MMgpd), and requires samples to be collected every three months and analyzed for the following parameters: chemical oxygen demand, temperature, suspended solids, pH, dissolved sulfides, ammonia (as nitrogen), oil and grease, total phenols, thiosulfate (as sulfur), flash point, mercaptans, benzene, toluene, and selenium (LACSD Permit No. 543R-3). In addition, ARCO is required to comply with federal pretreatment standards (Title 40 Code of Federal Regulations [CFR] 419), which govern the discharge of refinery wastewater to public treatment plants. No permit is required for federal standards as the LACSD permit requirements are more stringent than federal standards.

Terminals

Storm water at the terminals (including Marine Terminal 2) is collected, treated (if applicable), and discharged under the requirements of each terminal's NPDES permit or general stormwater discharge permit. In addition, each of the terminals maintains and follows a Storm Water Pollution Prevention Plan (SWPPP), which includes developing and implementing Best Management Practices (BMPs), conducting site inspections, training affected personnel, and updating the SWPPP as necessary.

In general, storm water drains that are located in terminal parking and vehicle access areas are directed to storm water drainage systems. Prior to release of storm water affected by industrial

activity to municipal storm sewer systems, water is collected and observed for an oily sheen. If a sheen is detected, the water is transported via pipeline or truck to LAR for processing. The non-contact stormwater from the collection system at the terminals is directed to local municipal storm sewer systems.

Storm water at the Carson Terminal discharges to the City of Carson's storm water system, which drains to the Dominguez Channel. The storm water discharge point is isolated from the city storm water system by a closed and locked isolation valve that is only opened to discharge storm water runoff.

Non-oily storm water from the Marine Terminal 2 is directed towards storm drains which discharge to the Pacific Ocean. Additionally, storm water from Marine Terminal 2 can be directed to tankage and then sent to LAR via pipeline.

Non-oily storm water from the East Hynes Terminal is directed towards storm drains which discharge to the Los Angeles River.

Non-oily storm water from the Hathaway Terminal is discharged to the Los Cerritos Channel. Typical sources of discharge to the Los Cerritos Channel include irrigation water from residential properties. The channel is regulated by the California Department of Fish and Game who periodically analyzes the water to ensure that it meets state regulatory standards for storm water (Strandberg, 2000).

The Vinvale Terminal discharges its non-oily storm water to the Los Angeles River which is located approximately ½ mile west of the terminal. Most of the water that enters the Los Angeles River year-round is from the Tillman Water Reclamation Plant in the Sepulveda Basin. Up to 75 million gallons of treated water from Tillman Water Reclamation Plant are released daily into the river. The RWQCB regulates the types of effluent being discharged to the Los Angeles River (Kennedy, 2000).

Non-oily storm water from the Colton Terminal is discharged to the Santa Ana River in accordance with RWQCB standards. Surface water from residential areas and the City of Rialto's wastewater treatment plant effluent is also discharged to the Santa Ana River (Fox, 2000).

3.2.1.2 Groundwater Quality

Los Angeles Basin

LAR and the Carson, Marine Terminal 2, East Hynes, Hathaway, and Vinvale Terminals are located in the Los Angeles Basin. Many of the shallow water-bearing units in the Los Angeles Basin area are hydraulically connected to offshore sediments. Withdrawal of fresh water from these zones has resulted in significant saltwater intrusion into the groundwater basins. This is particularly true of the West and Central Basins. Prior to commencement of the fresh water injection barrier project, saltwater had intruded, to various degrees, into all aquifer units with the exception of the Silverado water-bearing zone (ARCO, 1997).

Chapter 3 Setting

Groundwater resources are managed by the Water Replenishment District of Southern California (WRD), formerly known as the Central and West Basin Water Replenishment District. The State Department of Water Resources acts as the court-appointed Watermaster in connection with water rights adjudications. In addition to limiting total extractions from the Basin, groundwater resources management programs administered by the WRD include:

- Purchase of imported and reclaimed water for replenishment.
- Creation of fresh water barriers along the coast by injection of purchased imported water into injection wells. (This allows water levels in the more inland portions of the Basin to be drawn below sea level without the threat of seawater intrusion.)
- Monitoring groundwater quality and determining the relative quantities of local, imported, and reclaimed water to be used for replenishment (to maintain the chemical quality of the groundwater).

Several measures have been taken to stabilize groundwater levels in the project vicinity and thereby combat the further intrusion of seawater. Groundwater extractions are limited to adjudicated amounts under court control. Under the terms of court decrees in the adjudications, allowable annual pumpage was established at 64,468 acre-feet per year in the West Basin, which includes the area of LAR (WRD, 2000). One acre-foot equals 328,000 gallons or approximately enough water to supply a family of four for a minimum of one year. Since 1960, annual pumpage from the Basin has ranged from a low of 51,000 acre-feet to a high of 64,800 acre-feet. Total pumpage varies from year to year as a result of several factors, including carryover of overextractions (WRD, 2000).

Santa Ana Basin

The Colton Terminal is located in the Santa Ana Basin, which occupies approximately 2,700 square miles. In general, the quality of the ground water in the Santa Ana Basin becomes progressively poorer as water moves along hydraulic flow-paths. The highest water quality is typically associated with tributaries flowing from surrounding mountains and ground water recharged by these streams. Water quality in the Santa Ana Basin is altered by a number of factors including consumptive use, importing water high in dissolved solids, run-off from urban and agricultural areas, and the recycling of water within the Santa Ana Basin.

MTBE

The nationwide use of MTBE in gasoline dates back to 1979. As an oxygenate, meaning an oxygen containing compound, and an octane enhancing additive, MTBE offered more efficient and cleaner fuel combustion than lead, thereby reducing the level of air pollution.

In recent years, however, MTBE has been detected in ground and surface water. This is a matter of great concern in California because of the potential threat to the local water resources. To

address this issue, Senate Bill 521 (SB 521) directed to the University of California the responsibility of studying the human and environmental health impacts of MTBE.

These studies show environmental risks associated with the use of MTBE as an oxygenate in gasoline. In addition to its disagreeable taste and odor, this chemical compound is very water soluble and persistent in the environment.

Because of its high solubility, MTBE readily contaminates California's water reservoirs and infiltrates, at a rapid rate, subsurface aquifers. Ground and surface water contamination may result from point sources such as underground fuel tanks and surface pipelines. In consequence, Governor Davis banned the use of MTBE in reformulated gasoline.

3.2.2 Water Supply

LAR consumed a total of approximately 14,500 acre-feet of water during 1999. This consumption is equivalent to roughly 12.4 million gallons per day. About two-thirds of the water requirements are met by ARCO well water and the rest is purchased from California Water Service (CWS). The source of CWS water is the Metropolitan Water District and CWS's own wells, which pump groundwater from underlying aquifers.

Water is typically used for makeup supply to the refinery's boilers (makeup water is needed for water lost during normal boiler operations), cooling towers, utility water, fire water, and potable water systems.

3.2.3 Wastewater

Los Angeles Refinery

Wastewater streams discharged from the LAR include process wastewater, cooling tower blowdown, blowdown streams from the boiler feedwater treatment system and boiler, storm water runoff, and sanitary sewage (Figure 3.2-1).

Process wastewater streams containing ammonia and hydrogen sulfide are collected and treated separately from other process wastewater streams. The ammonia and hydrogen sulfide are stripped from the water and converted to harmless constituents. The treated wastewater is reused where feasible, and remaining water is then combined with other treated water and discharged to the LACSD sewer. The other process wastewater streams contain primarily oil and suspended solids. This wastewater is treated to remove free oil and suspended solids by conventional American Petroleum Institute (API) processes including oil/water separation, neutralization, polymer flocculation, and induced gas flotation. Free water is drained back to the wastewater treatment system and the remaining oil emulsion is processed further. The treated process wastewater is routed to an 840,000-gallon surge tank, from which it is routed through a 24-hour monitoring system and then discharged into the LACSD sewer.

Chapter 3 Setting

The boiler blowdown water is normally recycled for makeup water to the cooling towers. However, this water may also be cooled, neutralized, and discharged into the Dominguez Channel.

ARCO is permitted to discharge up to 7.57 million gallons of wastewater per day consisting of storm water runoff commingled with treated process wastewater (4.32 million gallons per day), boiler blowdown (0.37 million gallons per day), cooling tower blowdown (2.16 million gallons per day), and treated groundwater (0.72 million gallons per day) to Dominguez Channel at an outfall point approximately 2,200 feet west of the Alameda Street Bridge. Permitted effluent limits for discharge of treated storm water/process wastewater are listed in Tables 3.2-1 and 3.2-2.

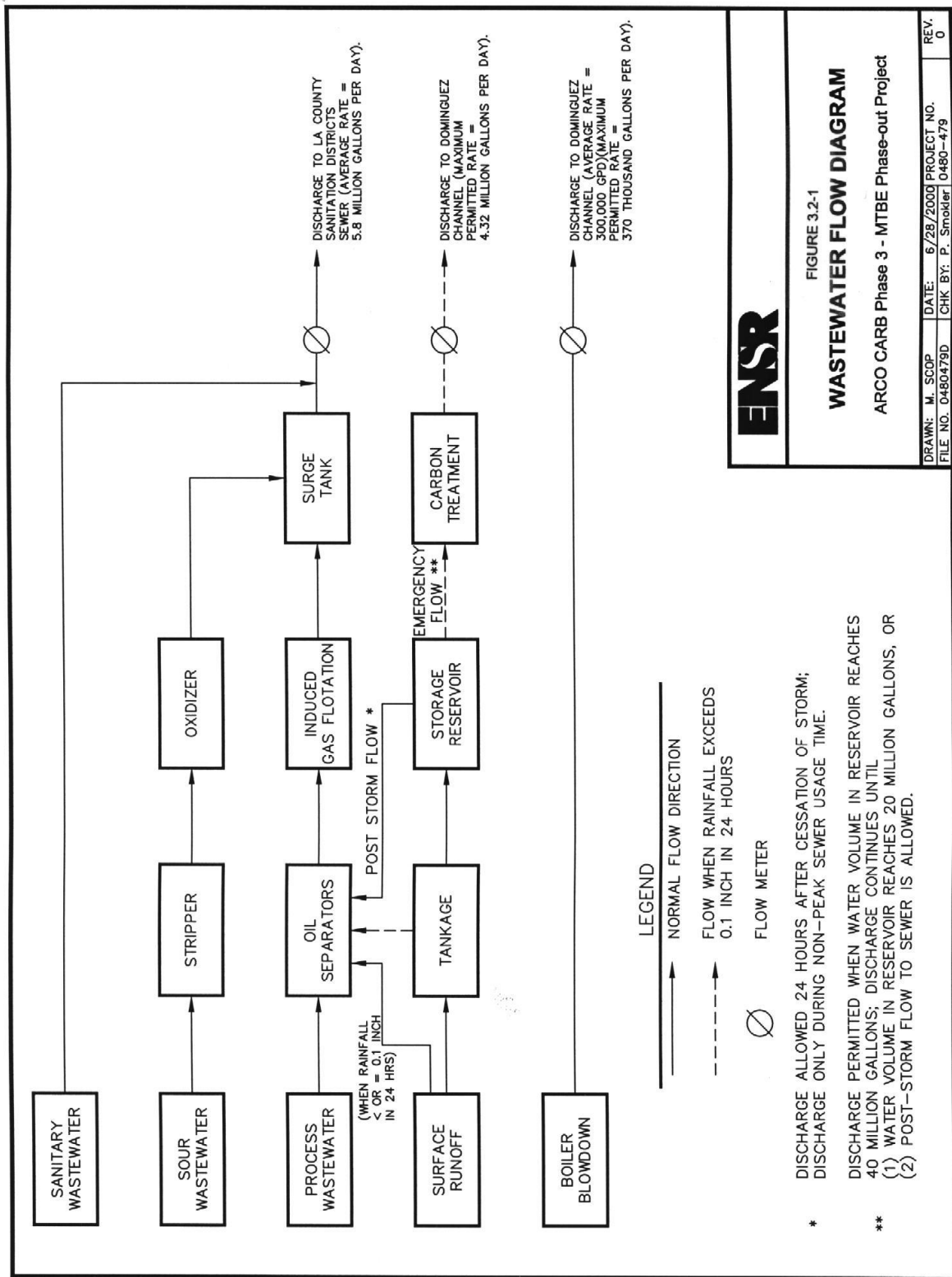

**Table 3.2-1
Waste Discharge Requirements for Discharge to Dominguez Channel**

Constituent	Units	Discharge Limitation	
		30-Day Average	Daily Maximum
Settable Solids	ml/l	0.1	0.3
Total suspended solids	mg/l	20	30
	lb/day	1,262	1,893
Chemical Oxygen Demand (COD)	lb/day	—	1,330
Oil and Grease	mg/l	10	15
	lb/day	634	947
Biological Oxygen Demand (5-day)	lb/day	—	1,968
Phenolic compounds (4 AAP)	lb/day	—	5.02
Ammonia as nitrogen	lb/day	—	470
Sulfides	lb/day	—	4.4
Total chromium	lb/day	—	10.4
Hexavalent chromium	lb/day	—	0.91

Source: Waste Discharge Requirements, NPDES Permit No. CA0000680, RWQCB, Los Angeles Region, 1999. Mass limitations (listed in pounds/day) are based on the maximum flow rate of 7.57 million gallons per day (mgd) of treated wastewater consisting of stormwater runoff commingled with process wastewater after treatment (4.32 mgd), cooling tower blowdown (2.16 mgd), and treated groundwater (0.72 mgd) to Dominguez Channel. The acute toxicity of the effluent shall be such that the average survival of laboratory specimens in undiluted effluent for any three consecutive 96-hour tests shall be at least 90 percent, with no single test producing less than 70 percent survival. The chronic toxicity of the effluent shall not exceed 1.0 toxicity units/chronic (TU). The waste discharge shall not increase the temperature of the receiving water and the pH of receiving water shall at all times be within the range of 6.5 to 8.5.

**Table 3.2-2
Treated Storm Water/Process Wastewater Discharge Limits to Dominguez Channel**

Constituent	Unit	Discharge Limitations		
		30-Day Average	Daily Average	Instantaneous Maximum
Arsenic (As)	µg/l	—	190	360
Cadmium (Cd)	µg/l	—	B	B
Chromium (VI) 2 (Cr + 6)	µg/l	—	11	16
Copper (Cu)	µg/l	—	C	C
Lead (Pb)	µg/l	—	D	d
Mercury (Hg)	µg/l	12	—	2,400
Nickel (Ni)	µg/l	4,600	E	e
Selenium (Se)	µg/l	—	5	20
Silver (Ag)	µg/l	—	—	f
Zinc (Zn)	µg/l	—	G	g
Aldrin	µg/l	140	—	—
1,1-dichloroethylene	µg/l	—	—	6
Trichloroethylene	µg/l	—	—	5
Tetrachloroethylene	µg/l	—	—	5
Vinyl Chloride	µg/l	—	—	0.5
Carbon Tetrachloride	µg/l	—	—	0.5
1,2-dichloroethane	µg/l	—	—	0.5
1,1-dichloroethane	µg/l	—	—	5
Ethylbenzene	µg/l	—	—	10
Chlorinated phenolic compounds	µg/l	—	—	1
1,2-dichlorobenzene	mg/l	18	—	—
1,3-dichlorobenzene	µg/l	2,600	—	—

**Table 3.2-2 (Cont.)
Treated Storm Water/Process Wastewater Discharge Limits to Dominguez Channel**

Constituent	Unit	Discharge Limitations		
		30-Day Average	Daily Average	Instantaneous Maximum
1,4-dichlorobenzene	µg/l	64	—	—
2,4,6-trichlorophenol	µg/l	1	—	—
Benzene	µg/l	1	—	21
Chlordane ³	pg/l	81	4,300	—
Chloroform	µg/l	480	—	—
DDT ³	pg/l	600	1,000	—
Dieldrin	pg/l	014	1.9	—
Endosulfan ³	ng/l	2,000	56	220
Endrin ³	ng/l	800	2.3	180
Halomethanes ³	µg/l	480	—	—
Heptachlor	pg/l	170	3,800	—
Heptachlor epoxide	pg/l	70	—	—
Hexachlorobenzene	pg/l	690	—	—
Hexachlorocyclohexane				
Alpha	ng/l	13	—	—
Beta	ng/l	46	—	—
Gamma	ng/l	62	80	—
Xylene	µg/l	—	—	10
PAHs ³	ng/l	31	—	—
PCBs ³	pg/l	70	14,000	—
Pentachlorophenol	µg/l	8.2	H	h
Toluene	µg/l	—	—	10
Toxaphene	pg/l	690	200	730,000
Fluoranthene	µg/l	42	—	—
Phenol	µg/l	—	—	1,000
Dichloromethane	µg/l	1,600	—	—
Residual chlorine	mg/l	—	—	0.1

µg/l micrograms per liter
mg/l milligrams per liter
ng/l nanograms per liter
pg/l picograms per liter

1 The discharge rate mass limitations in lbs/day shall be determined by using the concentration limits and the discharge flow rate.

2 Dischargers may, at their option, meet this limitation as total chromium

3 As defined in the California Inland Surface Waters Plan, 1991.

b= (daily average) Cd = 0.7825H-3.490; (instantaneous maximum) Cd = e1.128H-3.828

c= (daily average) Cd = 0.8545H-1.462; (instantaneous maximum) Cd = e0.9422H-1.464

d= (daily average) ≈ = e1.273H-4.705; (instantaneous maximum) Pb = e1.273H-1.460

e= (daily average) Ni = e0.846H + 1.1645; (instantaneous maximum) = 0.848H + 3.3612

f= (instantaneous maximum) = e1.725H – 6.52

g= (daily average) Zn = e0.8473H + 0.7614 (instantaneous maximum) Zn = e0.8473H + 0.8604

h= (daily average) Pentachlorophenol = e1.005 (pH)-5.290
(instantaneous maximum) Pentachlorophenol = e1.005 (pH)-4.830

Objectives for these metals (b-h) are expressed by the following formulas, where H = ln (hardness) in mg/l as CaCO₃ (if hardness is less than 25 mg/l, use 25 mg/l; if hardness is greater than 400 mg/l, use 400 mg/l).

Source: ARCO NPDES Permit No. CA0000680

Terminals

Wastewater generated at the terminals includes truck rack washdown water, tank water draws, condensate water from vapor recovery systems, air conditioning condensate, some exterior truck wash water and some storm water. Wastewater is directed to holding tanks and then transported via truck to Marine Terminal 2. From there, the contents of the tank at the Marine Terminal 2 are pumped via pipeline to the LAR for recovery and re-refining of the oily portion and treatment and discharge of the water. Alternatively, wastewater may be treated at some terminals in their own wastewater treatment systems and discharged to the local POTW under permit.

3.3 Noise

Noise is usually defined as sound that is undesirable because it interferes with speech communication and hearing, is intense enough to damage hearing, or is otherwise annoying (unwanted sound).

3.3.1 Guidelines and Local Ordinances

Noise impacts from the operation and construction of the modifications of the LAR and terminals are determined by the local city noise regulations summarized in Table 3.3-1, and by an incremental increase in existing noise. In addition, most community local noise elements contain land use compatibility standards required by the State of California. Figure 3.3-1 shows state land use categories and the recommended noise levels associated each.

**Table 3.3-1
Local Noise Guidelines and Ordinances**

City	Facility	Construction Limit (dBA)	Operations Limit (exterior dBA except where noted)					
			Residential ^{ab}	L ₅₀ =50	L ₂₅ =55	L _{8,3} =60	L _{1,7} =65	L _{max} =70
Carson	LAR Carson Terminal	Residential: L _{max} =60 (7 AM -8 PM) L _{max} =50 (8 PM -7 AM)	Commercial ^{ab}	L ₅₀ =60	L ₂₅ =65	L _{8,3} =70	L _{1,7} =75	L _{max} =80
			Industrial ^{ab} :	L ₅₀ =70	L ₂₅ =75	L _{8,3} =80	L _{1,7} =85	L _{max} =90
			Indoor Noise – Residences ^b : 45 day; 40 night					
			District 4 ^{ab} : L ₅₀ =70; L ₂₅ =75; L _{8,3} =80; L _{1,7} =85; L _{max} =90 Indoor Noise – Residences ^b : 45 day; 35 night					
Long Beach	East Hynes Terminal, Marine Terminal 2	No disturbing noise from 7 PM – 7 AM or weekends	District 4 ^{ab} : L ₅₀ =70; L ₂₅ =75; L _{8,3} =80; L _{1,7} =85; L _{max} =90 Indoor Noise – Residences ^b : 45 day; 35 night					
South Gate	Vinvale Terminal	None	Residential: ^c L _{dn} = 65 outdoors; L _{dn} = 45 indoors					

**Table 3.3-1 (Cont.)
Local Noise Guidelines and Ordinances**

City	Facility	Construction Limit (dBA)	Operations Limit (exterior dBA except where noted)
Signal Hill	Hathaway Terminal	None	Community Noise Equivalent Level (CNEL) CNEL = 60 to 65: Conditionally Acceptable ^c CNEL > 65: Normally Unacceptable ^c
Rialto	Colton Terminal	None	$L_{eq} = 67$ outdoors; $L_{eq} = 52$ indoors; $L_{dn} = 55$; ^c Normally Unacceptable Residential CNEL=65 ^c San Bernardino County: Residential CNEL=60 ^c
^a Residential and commercial nighttime limits (10 PM –7 AM) are 5 dBA lower. Tonal or impulsive type noise also reduces limit by 5 dBA. ^b If ambient noise exceeds limit then limit is increased to ambient noise. ^c Guidance based on city noise elements L_x - A-weighted sound level, L, that may not be exceeded more than “x” percent of the measured time period. L_{max} – Maximum A-weighted sound level			

3.3.1.1 Carson

The LAR and Carson Terminal are located within the City of Carson. Carson’s Municipal Code, Ordinance No. 95-1068, limits long-term construction noise (periods of 10 days or more) to 60 dBA in the daytime (7 AM to 8 PM) and 50 dBA in the nighttime (8 PM to 7 AM). In addition, construction occurring between 7 PM and 7 AM, or on Sundays may not cause a disturbance. If the City Engineer determines that the public health, safety, comfort, and convenience will not be affected during these times, he may grant special permission for noise-generating activities.

Carson's ordinance limits operational noise to specific statistical sound levels, L_x , where “L” is the A-weighted sound level that may not be exceeded over “x” percent of the measured time period. Carson bases its daytime (7 AM to 10 PM) limits on a 30-minute period and specifies the limits by zone (Zone 1: Noise Sensitive Areas; Zone 2: Residential; Zone 3: Commercial; Zone 4: Industrial).

Carson limits are summarized for Zones 2 through 4 (residential, commercial, and industrial) in Table 3.3-1. No areas near LAR or the Carson Terminal are designated Zone 1. For residential and commercial areas, nighttime (10 PM to 7 AM) limits are 5 dBA lower. If the existing ambient noise level already exceeds these limits then the noise limit becomes equal to the existing ambient noise level. In addition, interior (indoor) noise levels are limited to 40 dBA nighttime (10 PM to 7 AM) and 45 dBA daytime, or the existing ambient noise level in residential dwellings whichever is greater. For sources of tonal or impulsive noise, noise ordinance limits are reduced by 5 dBA.

Figure 3.3-1 Land Use Compatibility for Community Noise Environments

Chapter 3 Setting

Land Use Category	Community Noise Equivalent Level (CNEL) in dBA					
	55	60	65	70	75	80
Residential Single Family, Duplex, Mobile Homes						
Residential, Multiple Family						
Transient Lodging						
School Classrooms, Libraries, Churches						
Hospitals, Nursing Homes						
Auditorium, Concert Halls, Music Shells						
Sports Arena, Outdoor Spectator Sports						
Playgrounds, Neighborhood Parks						
Golf Courses, Riding Stables, Water Recreation, Cemeteries						
Office Buildings, Personal, Business and Professional						
Commercial Retail, Movie Theaters, Restaurants						
Commercial Wholesale, Some Retail, Ind. Mfg. Utilities						
Livestock, Farming, Animal Breeding						
Agriculture (Except Livestock), Mining, Fishing						
Public Right Of Way						
Extensive Natural Recreation Areas						
Source: ARCO Polypropylene EIR 1997						

Interpretation



Clearly Acceptable

The noise exposure is such that the activities associated with the land use may be carried out with essentially no interference from aircraft noise (residential areas both indoor and outdoor noise environments are pleasant).



Normally Acceptable

The noise exposure is great enough to be of some concern, but common building construction will make the indoor environment acceptable even for sleeping quarters.



Normally Unacceptable

The noise exposure is significantly more severe so that unusual and costly building construction is necessary to insure adequate performance of activities (residential area barriers must be erected between the site and prominent noise sources to make the outdoor environment tolerable).



Clearly Unacceptable

The noise exposure is so severe that construction costs to make the indoor environment acceptable for performance of activities would be prohibitive (residential areas: the outdoor environment would be intolerable for normal residential use).

3.3.1.2 Long Beach

The East Hynes Terminal and Marine Terminal 2 are located within the City of Long Beach. The Long Beach Noise Ordinance (Chapter 8.80) prohibits annoying or disturbing construction noise from 7 PM to 7 AM on weekdays; until 9 AM on Saturdays; and anytime on Sundays.

The Long Beach Noise Ordinance limits the outdoor operational noise by Noise District to a 60 minute L_{50} , L_{25} , $L_{8.3}$, $L_{1.7}$, and L_{max} . Both the East Hynes Terminal and the Marine Terminal 2 are located within Noise District 4, with exterior noise limits as summarized in Table 3.3-1. Interior noise levels are limited within residences to 35 dBA nighttime (10 PM to 7 AM) and 45 dBA daytime; within schools to 45 dBA daytime and within hospitals to 40 dBA. If the existing ambient noise already exceeds these limits, then the limits are raised in 5 dBA increments to encompass the high ambient noise. Noise ordinance limits are reduced by 5 dBA for tonal or impulsive noise sources.

3.3.1.3 South Gate

The Vinvale Terminal is located within the City of South Gate. The South Gate General Plan refers to the Community Noise Equivalent Level (CNEL) land-use compatibility matrix and noise standard table. The South Gate Plan limits the day-night sound levels (L_{dn}) to 65 dBA outdoors and 45 dBA indoors. The South Gate Plan does not address construction noise.

3.3.1.4 Signal Hill

The Hathaway Terminal is located within the City of Signal Hill. The Signal Hill General Plan bases its noise limitations on a CNEL land-use compatibility matrix. Based on the matrix, a CNEL of greater than 65 dBA would be “normally unacceptable” for residential land use, and a CNEL of 60 to 65 dBA would be “conditionally acceptable”. The Signal Hill Plan does not address construction noise.

3.3.1.5 Rialto

The Colton Terminal is located within the City of Rialto in San Bernardino County. The City of Rialto General Plan limits outdoor noise to an equivalent sound level (L_{eq}) of 67 dBA outdoor or 52 dBA indoors, and limits the L_{dn} to 55 dBA. The Rialto General Plan also specifies a CNEL of 65 dBA for residences as “normally unacceptable” and refers to the San Bernardino County noise standard that limits residential exterior noise to a CNEL of 60 dBA. The Rialto Plan does not address construction noise.

3.3.2 Existing Noise Environment

Existing ambient CNELs at the Vinvale, Hathaway, and Colton Terminals are based on municipal noise surveys and resulting CNEL contour maps in each municipality’s noise ordinance.

Municipal noise surveys and CNEL contour maps are not available for the Marine Terminal 2 and East Hynes Terminals located within the City of Long Beach. At Marine Terminal 2 and East

Hynes Terminal, the existing ambient CNELs are based on area land use assignments (Districts) specified on the City of Long Beach Noise Ordinance's Noise District Map. According to the City Ordinance, District 1 is "predominantly residential", District 2 is "predominantly commercial", and District 3 is "predominantly industrial", although each of these districts have "other land use types present".

3.3.2.1 LAR and Carson Terminal

LAR and the Carson Terminal are surrounded by industrial, commercial, transportation, and some residential land uses. Land uses are further described in Section 3.4. The ambient noise environment in the project vicinity is composed of the contributions from equipment and operations within these commercial and industrial areas, from rail activities, from the traffic on the major transportation routes (Interstate 405, 223rd Street, Wilmington Avenue, Sepulveda Boulevard, and Alameda Street), and from other individual activities in the area.

The nearest residential areas are located approximately 3,000 feet southwest of LAR along Sepulveda Boulevard and approximately 3,000 feet northwest along Lucerne Street and 223rd Street. The nearest commercial land is located west and northwest of LAR, just west of Wilmington Avenue and south of 223rd Street.

Previous noise studies and noise measurements were performed in the LAR area in 1984 and 1992 (Dames & Moore, 1985; SCAQMD, 1993) in support of the ARCO Watson Refinery Modernization Project EIR and ARCO Clean Fuels Projects EIR, respectively. Existing ambient sound levels were evaluated in support of the Polypropylene Project in 1997 (Polypropylene EIR, 1997). The existing CNEL noise environments in the vicinity of residences to the southwest are 64 dBA and in the "normally acceptable" range for their land use categories (Polypropylene EIR, 1997). The existing CNEL noise environments in the vicinity of residences to the northwest is 63 to 71 dBA and in the "normally acceptable to normally unacceptable" range for their land use categories (Polypropylene EIR, 1997). The existing CNEL noise environments in the vicinity of commercial receptors to the west and northwest are 72 to 75 dBA, and are in the "normally acceptable" range for their land use categories (Polypropylene EIR, 1997).

3.3.2.2 Marine Terminal 2

Land use around the Marine Terminal 2, which lies within Long Beach Noise District 4, consists of industrial land within ½-mile to the north, west and south. To the immediate east of Marine Terminal 2 lies Interstate 710 and the Los Angeles River. The nearest receptor is to the east in an area zoned for residential development located approximately ½-mile away.

The existing CNEL noise environment in the vicinity of Marine Terminal 2 has not been measured; however, the CNEL is assumed to be about 65 to 75 dBA to the north, west, and south, and 60 to 65 dBA to the east. The assumed ambient CNELs are based on area land use assignments (Districts) specified on the City of Long Beach Noise Ordinance's Noise District Map (1993). According to the City Ordinance, District 1 is "predominantly residential", District 2 is

“predominantly commercial”, and District 3 is “predominantly industrial”, although each of these districts have “other land use types present”.

3.3.2.3 East Hynes Terminal

Land use around the East Hynes Terminal, which lies within Long Beach Noise District 4, is surrounded by industrial and commercial land except to the northwest and east. The nearest residences lie approximately 300 feet northwest of the East Hynes Terminal property line along Poppy, Curry, and Harding Streets just west of the Union Pacific Railroad.

The existing CNEL noise environment in the vicinity of East Hynes Terminal has not been measured; however, the CNEL is assumed to be about 65 to 75 dBA in the industrial and commercial areas, and 60 to 65 dBA in the residential area. The assumed ambient CNELs are based on area land use assignments (Districts) specified on the City of Long Beach Noise Ordinance’s Noise District Map. According to the City Ordinance, District 1 is “predominantly residential”, District 2 is “predominantly commercial”, and District 3 is “predominantly industrial”, although each of these districts have “other land use types present.”

3.3.2.4 Vinvale Terminal

Land use around the Vinvale Terminal consists of manufacturing, heavy manufacturing or planned industrial land in all immediate directions. The nearest residences are two mobile home parks along Shull Street that lie approximately 800 feet north of the Vinvale Terminal, north of a planned industrial development tract.

The existing ambient CNEL around the Vinvale Terminal has not been measured. The estimated ambient CNELs at the Vinvale Terminal range from 60 to 65 dBA and are based on noise surveys conducted by South Gate and the CNEL contour maps published in the municipality’s noise ordinance (South Gate General Plan 1986).

3.3.2.5 Hathaway Terminal

Land use around the Hathaway Terminal consists of commercial and industrial land to the northwest, north, northeast, and southeast, and industrial to the northwest, northeast, and southeast. The nearest residential receptors lie to the southwest along Hathaway Avenue in the Bixby Ridge housing development (under construction).

The existing ambient CNEL around the Hathaway Terminal has not been measured. The estimated ambient CNELs at the Hathaway Terminal are expected to be approximately 60 to 65 dBA, and are based on noise surveys conducted by Signal Hill and the CNEL contour maps published in the municipality’s noise ordinance (Signal Hill General Plan 1991).

3.3.2.6 Colton Terminal

Land use around the Colton Terminal consists generally of heavy industrial land on all sides of the terminal. The nearest residential receptors lie in this heavy industrial zone approximately 200 feet west and southwest of the Colton Terminal along Santa Ana Avenue.

The existing ambient CNEL around the Colton Terminal has not been measured. The estimated ambient CNELs at the Colton Terminal are expected to be between 60 and 65 dBA and are based on noise surveys conducted by Rialto and the CNEL contour maps in the municipality's noise ordinance (Rialto Noise Element of the General Plan 1991).

3.4 Land Use and Planning

This section provides a discussion of existing land uses in the vicinity of each of the affected project sites.

3.4.1 Regional Setting

With the exception of the Colton Terminal (located in the City of Rialto, San Bernardino County), the LAR and all other terminals are located in southern Los Angeles County. This area of the southern portion of Los Angeles County is generally urbanized and includes a substantial amount of industrial and port-related development, due to the proximity of the Ports of Los Angeles and Long Beach. Both the LAR and the Carson Terminal are located in the City of Carson. Both the East Hynes Terminal and Marine Terminal 2 are located within the City of Long Beach. The Hathaway Terminal is located within the City of Signal Hill and the Vinvale Terminal is located within the City of South Gate. The Colton Terminal is located within the City of Rialto in western San Bernardino County.

Los Angeles County is one of the nation's largest counties, encompassing 4,083 square miles. It is bordered on the east by Orange and San Bernardino counties, on the north by Kern County, on the west by Ventura County, and on the south by the Pacific Ocean. It has the largest population (9.8 million as of July, 1999) of any county in the nation and approximately 29 percent of California's residents live in Los Angeles County (County of Los Angeles, 2000).

San Bernardino County is comprised of over 20,000 square-miles and is part of the Inland Empire (derived of eastern Los Angeles, San Bernardino and Riverside Counties). It is one of the fastest growing metropolitan areas of the United States, with an estimated population of 1.6 million people (County of San Bernardino, 2000).

The areas surrounding the project sites can generally be characterized as a blend of heavy and light industrial, commercial, medium- and high-density residential, industrial/manufacturing, and transportation-related land uses.

3.4.2 Project Site and Vicinity Land Uses

LAR

The proposed modifications to the LAR will be developed within existing LAR property boundaries. Land use on the refinery grounds and within the immediate vicinity is dominated by heavy industry and manufacturing.

Land to the north of LAR between Wilmington Avenue and Alameda Street is occupied by heavy industrial uses and vacant land formerly occupied by heavy industry. Land north of 223rd Street to Interstate 405 is occupied by commercial uses, such as automobile dealerships and automobile repair services.

Land uses east of LAR includes the Watson Intermodal Container Transfer Facility (ICTF), Union Pacific Railroad tracks, and Alameda Street, a major port access arterial. Land east of Alameda Street is occupied by heavy industrial uses including a sulfur recovery facility, auto wrecking yards, and the ICTF. Land to the east of the ICTF is in the City of Long Beach and includes a residential neighborhood and light manufacturing facilities.

South of the LAR is Sepulveda Boulevard and the Tosco refinery. This area is dominated by storage tanks and refinery equipment. Land south of the Tosco refinery is in the City of Los Angeles and is dominated by port-related industrial activities.

West of the refinery is Wilmington Avenue. Land adjacent to Wilmington Avenue on the west is occupied by the Watson Industrial Park, a development of manufacturing and warehouse-type structures. Land west of Wilmington Avenue and south of Sepulveda Boulevard, immediately west of ARCO's southwest tank farm, is a residential neighborhood and represents the closest residences to LAR. Other single-family residences are located more than 1,000 feet northwest of the LAR on the other side of Interstate 405.

Carson Terminal

The Carson Terminal is located to the southeast of the LAR in the City of Carson. Land use in the immediate vicinity is dominated by heavy industry and manufacturing.

To the north of the terminal is a coke storage facility, beyond which are a sulfur recovery plant and the Watson ICTF.

Adjacent to the east side of the terminal is the Dominguez Channel, beyond which is a rail car storage yard, a petroleum storage facility, and Union Pacific Railroad Tracks.

To the south of the terminal is Sepulveda Boulevard, beyond which is an Equilon terminal. This area is dominated by storage tanks and other petroleum-related uses.

Adjacent to the west of the terminal is a construction yard, a storm water retention pond, and ARCO employee parking. Beyond the construction yard and parking lot is Alameda Street and the southeastern portion of the LAR.

Marine Terminal 2

Chapter 3 Setting

Marine Terminal 2 is located in the Port of Long Beach adjacent and to the north of Channel No. 2 in the City of Long Beach. Land use in this area of the Port of Long Beach is predominantly industrial.

To the north of the terminal is vacant land formerly used for industrial purposes, beyond which are Pier B Street and Union Pacific Railroad tracks. The area to the north of the railroad tracks is used for industrial purposes and is occupied by large warehouse-type structures.

Adjacent and to the east of the terminal are Pico Avenue and Harbor Scenic Drive, beyond which are the Los Angeles River and the 710 freeway. Land to the east of the 710 freeway is used for light industrial purposes.

To the south of the terminal is Channel No. 2 of the Inner Harbor area of the Port. Several oil terminals and shipping terminals are located on the south side of Channel No. 2.

Adjacent and to the west of the terminal is a construction storage yard. Beyond the yard are additional industrial facilities, including a Texaco Oil terminal and a Petro-Diamond Oil terminal.

East Hynes Terminal

The East Hynes Terminal is located in North Long Beach in a mixed-use area consisting of industrial, commercial, and residential facilities.

To the north of the terminal is a construction yard. Beyond the construction yard are additional industrial and warehouse-type facilities.

Adjacent and to the east of the terminal is Paramount Boulevard, beyond which are light industrial and commercial facilities, including equipment/truck rental companies, a retail construction supply facility, and automobile dealerships.

To the south of the terminal are light industrial and industrial facilities, including automobile repair facilities, a self-storage facility, an asphalt plant, and a construction sales operation. Beyond these facilities is South Street, and beyond that are additional commercial facilities and residences.

Adjacent and to the west of the terminal are Union Pacific Railroad tracks. Beyond the railroad tracks are a petroleum terminal and residences.

Vinvale Terminal

The Vinvale Terminal is located in the eastern portion of the City of South Gate, just east of the 710 freeway. Land uses in the immediate vicinity of the terminal are primarily commercial and industrial, with some residential to the north.

Adjacent and to the north of the terminal are the Union Pacific Railroad tracks, beyond which are two mobile home parks, a light industrial development with auto and truck repair facilities, a toy manufacturer, and construction equipment sales and repair businesses. The mobile home parks

and light industrial development on the north side of the Union Pacific Railroad tracks are located within the Bell Gardens city limits.

The west side of Garfield Avenue is the terminal's eastern boundary. Beyond Garfield Avenue to the southeast of the terminal are restaurants and a multi-tenant commercial strip mall, including a Target department store. Directly east of the terminal, on the west side of Garfield Avenue, is a 300,000 square foot shopping mall under construction.

The terminal is bordered to the south by Firestone Place, beyond which are commercial and light industrial facilities, with a hotel, a cosmetic wholesaler/manufacturer, automobile dealerships, a freight shipping company, and auto repair shops.

The terminal is bordered to the west by the 710 freeway and the Los Angeles River. Beyond the 710 freeway and the river, land uses are primarily industrial in nature, such as machine shops, steel processing facilities, and scrap metal recycling facilities.

Hathaway Terminal

The Hathaway Terminal is located in the City of Signal Hill, south of the Long Beach Municipal Airport and Interstate 405. Land uses in the immediate vicinity of the terminal vary from residential to commercial and light industrial. The terminal is oriented northeast to southwest, with the main truck entrance and exits on Hathaway Avenue.

Land adjacent to the north and northeast of the terminal is used for commercial purposes, including an Office Depot warehouse and office complex and multi-tenant commercial strip malls. The Office Depot complex and strip malls front Willow Street and Redondo Avenue.

Adjacent to the east and southeast of the terminal are an Equilon gasoline/oil distribution facility and a development including manufacturing and warehouse-type structures.

The north side of Hathaway Avenue is the terminal's southwestern boundary. On the south side of Hathaway Avenue, the Bixby Ridge housing development is in the final stages of construction.

Adjacent to the terminal's northwestern boundary are commercial, light industrial, and heavy industrial facilities, including a machine shop, an auto repair shop, a plumbing contractor, party supply sales, and an arts and crafts store.

Colton Terminal

The Colton Terminal is located in the City of Rialto south of Interstate 10. Land uses in the immediate vicinity of the terminal are primarily light and heavy industrial. Land north, east, and south of the terminal is occupied by a Tosco gasoline/oil distribution facility. Beyond the Tosco terminal tanks to the east of the ARCO terminal are the Rialto Channel (San Bernardino County Flood Control District) and vacant land located within the City of Colton.

Adjacent and to the south of the terminal are additional storage tanks and loading facilities associated with the Tosco facility, beyond which is Santa Ana Avenue. Adjacent and to the

southeast of the terminal is vacant land. Land south of Santa Ana Avenue is occupied by heavy industrial uses including an auto wrecking yard and a rock quarry.

The east side of Riverside Avenue is the terminal's western boundary. On the west side of Riverside Avenue, west and northwest of the terminal, land uses include commercial and light industrial businesses, such as truck and auto repair shops, air conditioning repair shops, and construction equipment sales/service facilities.

Residences are located west and southwest of the terminal on Santa Ana Avenue, approximately 200 feet from the terminal's western boundary.

3.4.3 Zoning

The following is a summary of the zoning designations for the LAR and the terminals.

LAR

The LAR is zoned by the City of Carson as MH (Manufacturing, Heavy). Zoning surrounding the LAR (see Figure 3.4-2) is also MH with the exception of the following areas (City of Carson, 2000):

- Zoning is a mixture of ML (Manufacturing, Light), RS (Residential, Single-Family), RM (Residential, Multi-Unit), and CG (Commercial, General) to the northwest across East 223rd Street.
- Zoning is MH-ORL (Manufacturing, Heavy - Organic Refuse Landfill Overlay District) to the east of Alameda Street.
- Zoning is RS, ML, and a small strip of OS (Open Space) on the Los Angeles Department of Water and Power easement to the southwest.

Land use at LAR and in the surrounding vicinity is consistent with the City of Carson General Plan land use designations for the area. The Land Use element of the General Plan currently in force was revised in May 1982. No revisions to the Land Use element have occurred since May 1982, although the General Plan is currently being revised (Raktiprakorn, 2000).

ARCO has a Special Use Permit from the City of Carson for development of projects within the original property boundaries that existed before Carson was incorporated. The portion of LAR that formerly belonged to the Johns-Manville Corporation (now referred to as the Northeast Property) and the railcar loading facility operate under a Conditional Use Permit (CUP) from the City of Carson (Raktiprakorn, 2000). Figure 3.4-1 depicts zoning in the vicinity of the LAR.

Carson Terminal

The Carson Terminal is zoned by the City of Carson as MH, Manufacturing, Heavy. Zoning to the north, east, south, and west of the terminal is also MH.

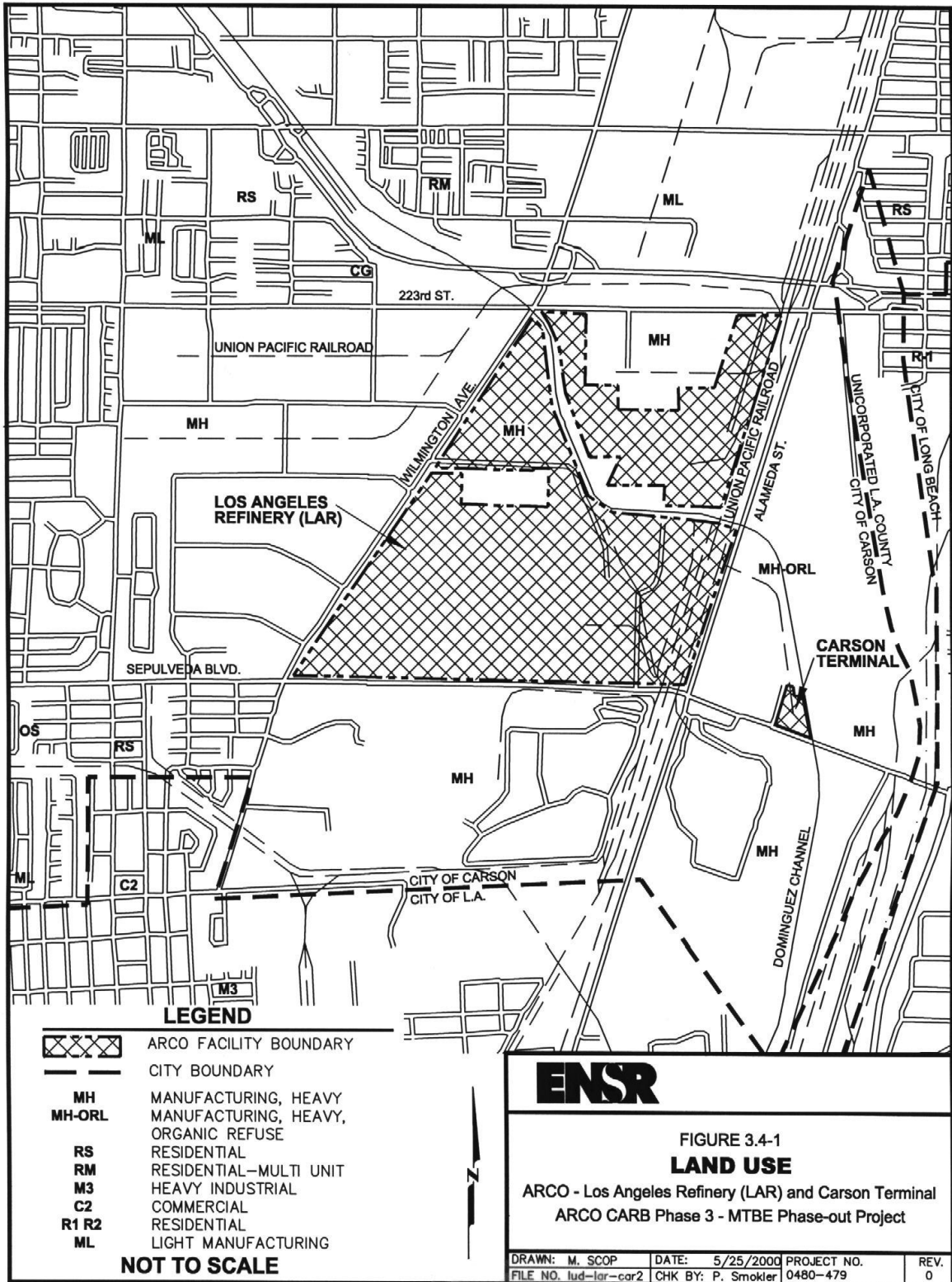

Chapter 3 Setting

Land use at the terminal is a permitted use in the MH zone under a Conditional Use Permit. Land use at the terminal is consistent with the City of Carson General Plan land use designations for the area. The Land Use element of the General Plan currently in force was revised in May 1982. No revisions to the Land Use element have occurred since May 1982, although the General Plan is currently being revised. Figure 3.4-1 depicts zoning in the vicinity of the Carson Terminal.

Marine Terminal 2

The Marine Terminal 2 is zoned by the City of Long Beach as IP, Port-Related Industrial. Zoning to the north, south, and west of the terminal is also IP, while zoning to the east beyond the Los Angeles River is PD, Planned Development.

Land use at the terminal site is a permitted use in the IP zone and is consistent with the Port Master Plan. Projects proposed in the IP district are subject to review by the Harbor Department (City of Long Beach, 1995). Figure 3.4-2 depicts land uses and zoning in the vicinity of the Marine Terminal 2.

East Hynes Terminal

The East Hynes Terminal is zoned by the City of Long Beach as IG, General Industrial. Zoning to the north, east, south, and west is also IG. Land use at the terminal site is a permitted use in the IG zone. Projects proposed at the terminal site are subject to plan check review, but because the site use is permitted by right (site in use as a terminal prior to zoning changes), no environmental review would be required by the City of Long Beach (Krupka, 2000). Figure 3.4-3 depicts the zoning in the vicinity of the East Hynes Terminal.

Vinvale Terminal

The Vinvale Terminal is located in the South Gate Triangle planning area, which according to the City of South Gate General Plan, is a mixed-use area consisting of both commercial and industrial uses. The terminal site is zoned by the City of South Gate as M-3, Heavy Manufacturing. Zoning to the east and west is also M-3, while zoning to the south of Firestone Boulevard is C-M, Commercial Manufacturing (see Figure 3.4-4). The area north of the Union Pacific Railroad tracks that borders the terminal to the north, is zoned by the City of Bell Gardens as MPD, Manufacturing-Industrial Planned Development. The area to the north of this industrial area is residential and is zoned by the City of Bell Gardens as R-3, Medium Density Multi-Family Residential.

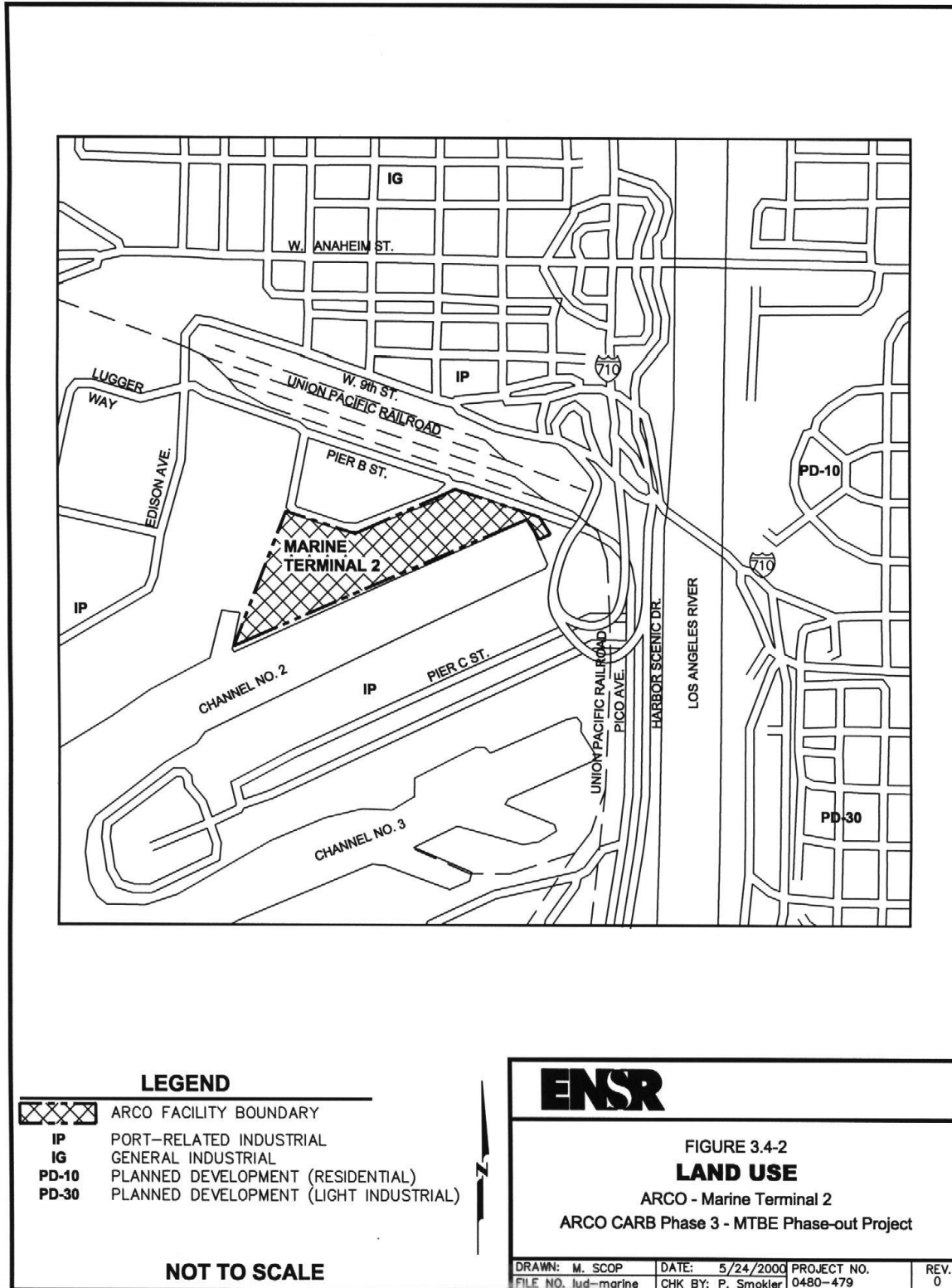

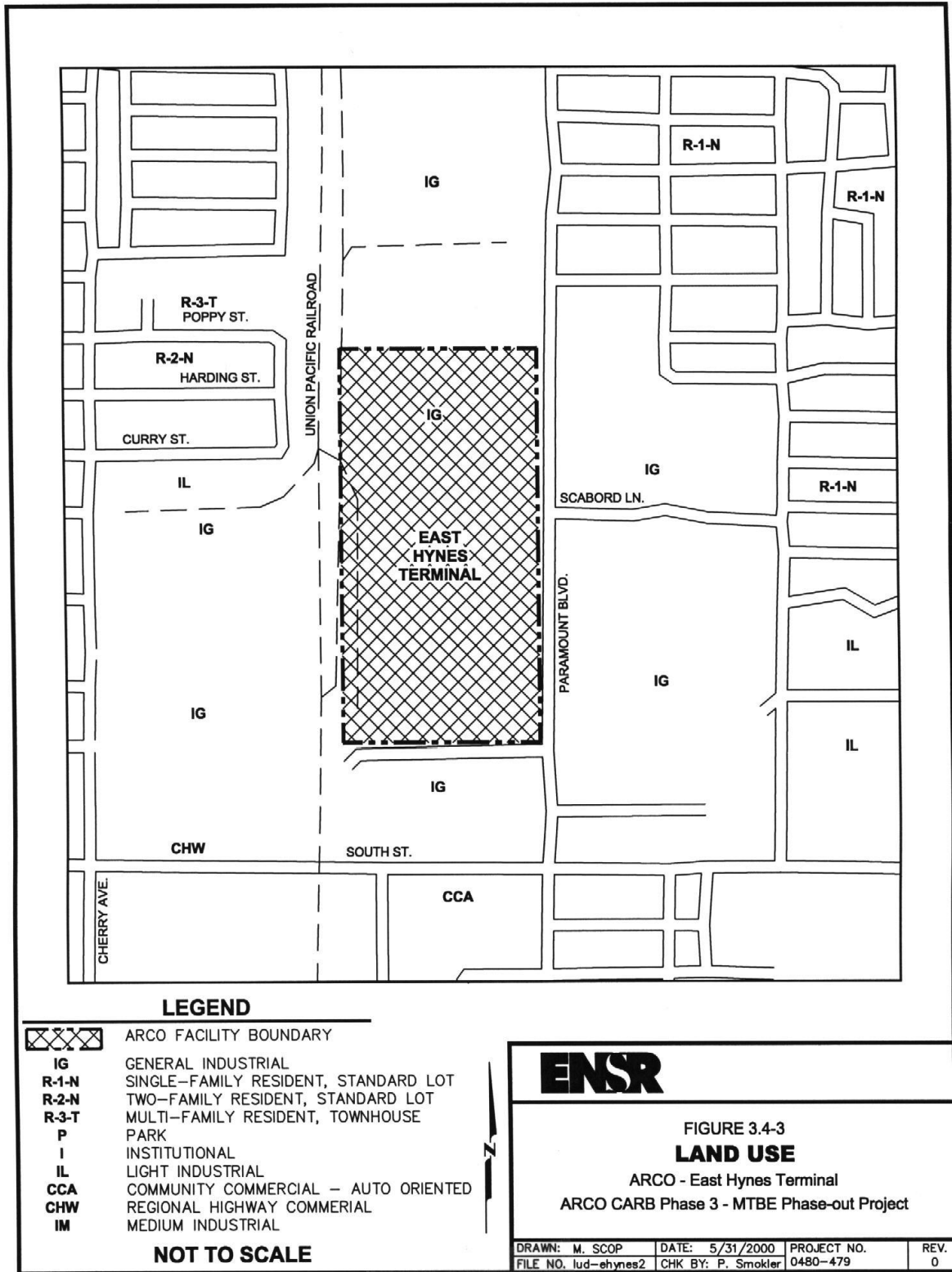

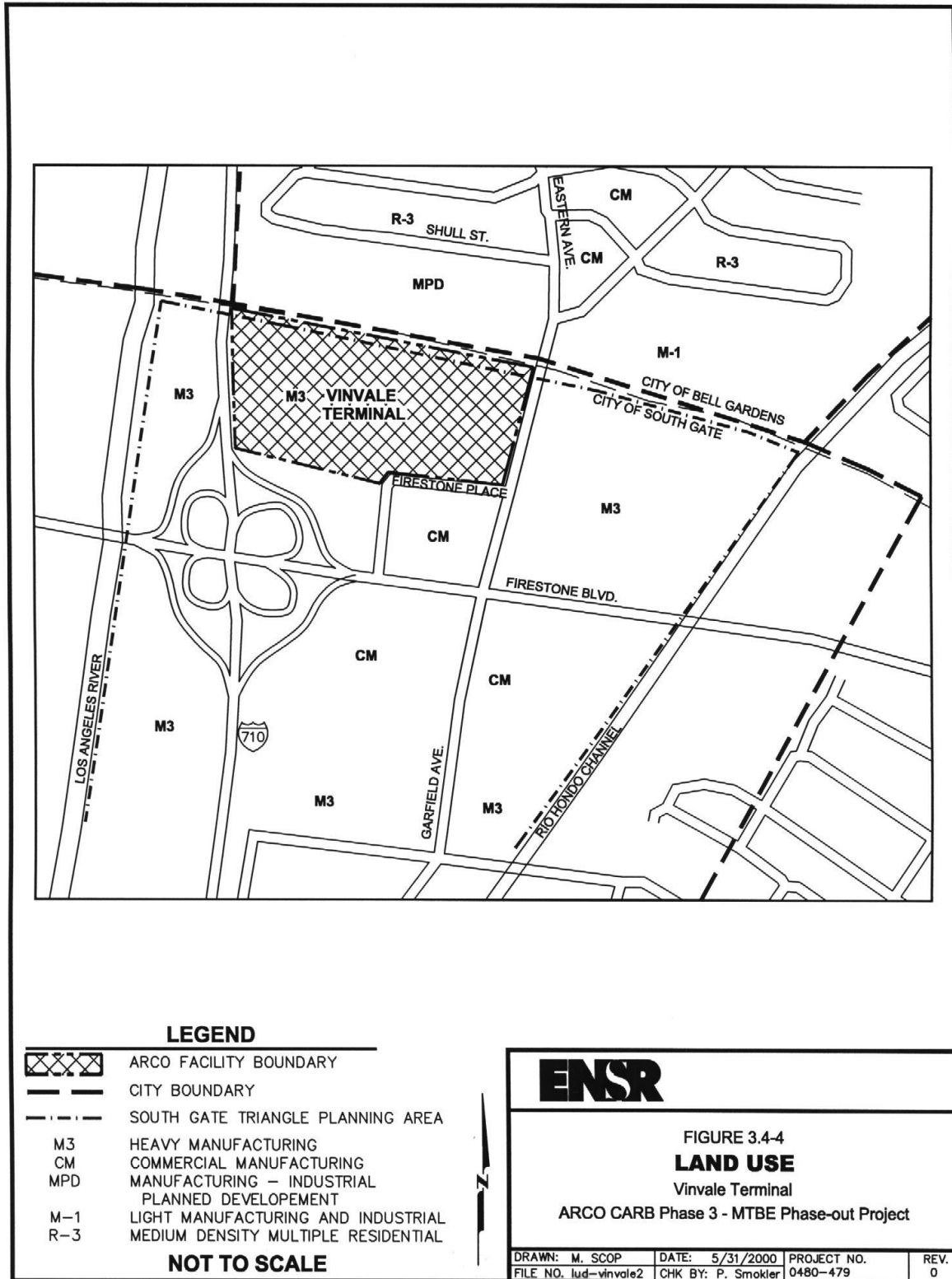

Land use at the terminal is a permitted use in the M-3 zone and is consistent with the City of South Gate General Plan land use designations (Lefever, 2000). The Land Use Element of the General Plan currently in force was adopted in November 1986. No revisions to the Land Use Element have occurred since 1986. Figure 3.4-4 depicts zoning designations in the vicinity of the Vinvale Terminal.

Hathaway Terminal

The Hathaway Terminal is zoned by the City of Signal Hill as GI, General Industrial, with the exception of the portion of the terminal site fronting Hathaway Avenue, which is zoned LI, Light Industrial. Zoning to the east and west is also GI, while zoning to the north and northeast is CI, Commercial Industrial. Land to the southeast and southwest is zoned LI, Light Industrial, and the residences located on the south side of Hathaway Avenue are located in the Bixby Ridge Specific Plan. Land use at the terminal is a non-conforming use under the current zoning ordinance.

Because the facility has been used for the storage and distribution of petroleum since 1959, the terminal is a permitted use under CUP No. 79-01. Figure 3.4-5 depicts zoning designations in the vicinity of the Hathaway Terminal.

Colton Terminal

The Colton Terminal is zoned by the City of Rialto as H-IND, Heavy Industrial. Zoning to the north, south, east, and west are also zoned H-IND. The area to the east and beyond the Rialto Channel is zoned by the City of Colton as City of Colton Specific Plan. The terminal is located in the Aqua Mansa Industrial Corridor Specific Plan Area. This area is planned and administered by joint powers agreements between the Cities of Rialto and Colton and the Counties of San Bernardino and Riverside.

The Colton Terminal operates under a Precise Plan of Design, which outlines various conditions for development and operation at the site (Montag, 2000). Zoning designations in the vicinity of the Colton Terminal are included on Figure 3.4-6.

3.4.4 Land Use Plans

The following information summarizes land use development plans in the areas of the LAR and the terminals.

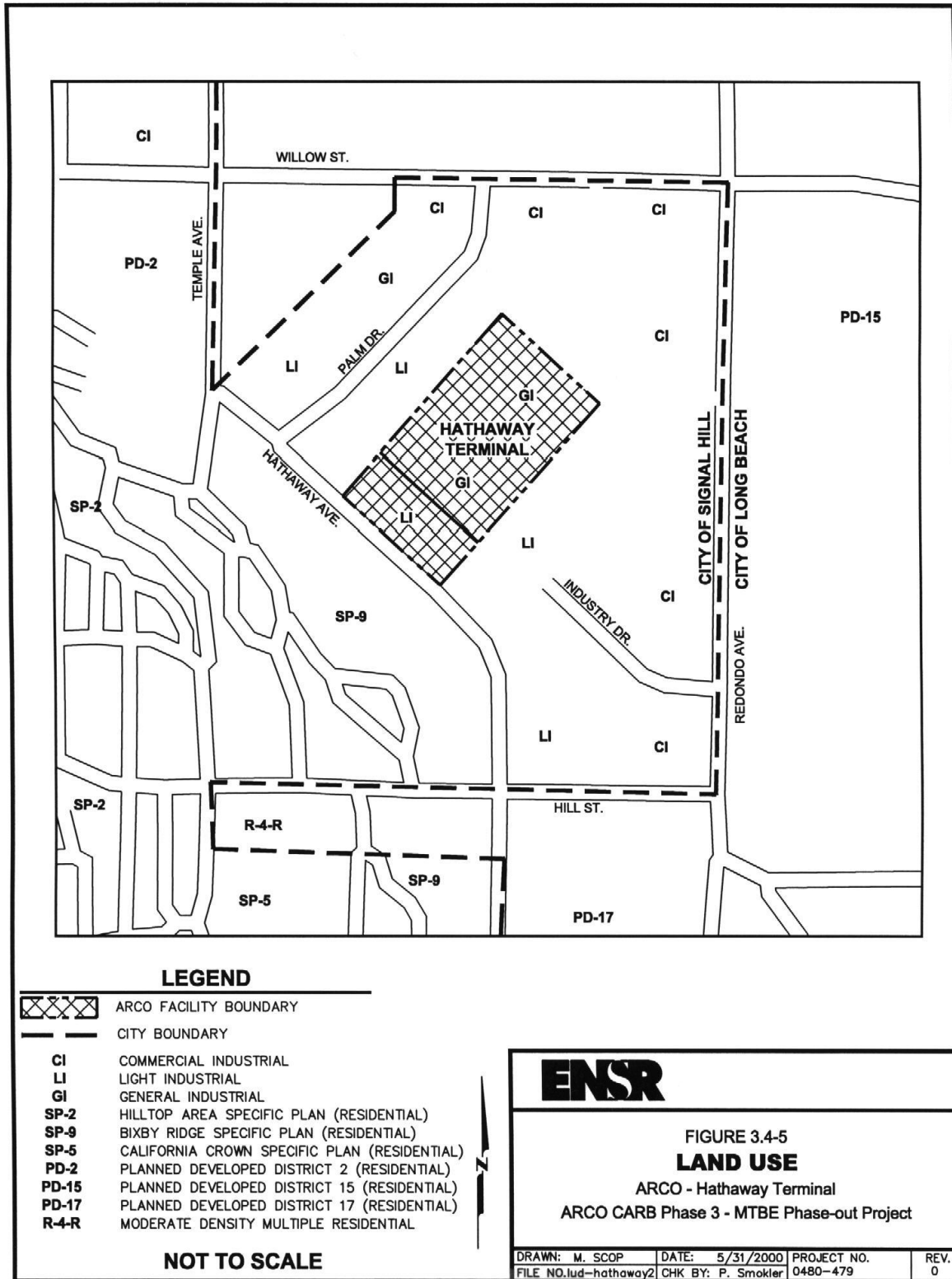

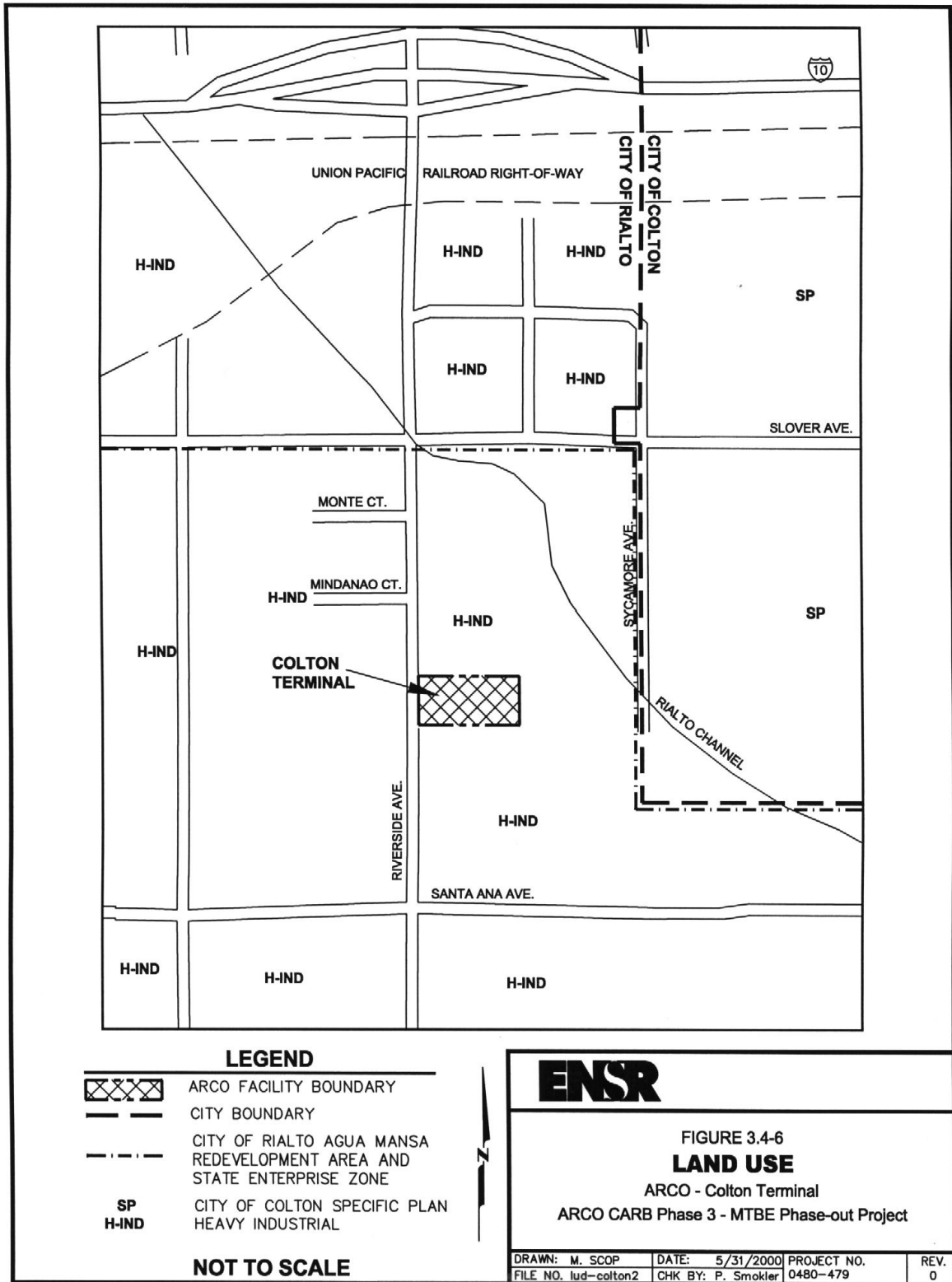

LAR and Carson Terminal

According to the Draft Air Quality Element of the City of Carson General Plan (JHA, 1992), in 1992, 40 percent of the land area in Carson was zoned industrial. The city is attempting to develop more light industrial facilities, including offices and research parks, and move away from heavy industrial uses (JHA, 1992).

The strip of Los Angeles that borders the eastern boundary of the City of Carson is part of the Port of Los Angeles Community Plan and the portion of Los Angeles that borders Carson on the south is part of the San Pedro-Wilmington Community Plan.

The City of Long Beach is 90 percent built out in the western portion that borders the City of Carson. No plans to alter land uses or zoning in the western part of Long Beach are currently in effect (Felgemaker, 2000).

Marine Terminal 2

The Marine Terminal 2 is located in the City of Long Beach's Harbor/Airport planning district. No significant changes in the boundaries or composition of this land use district are planned (City of Long Beach, 1997). The California Coastal Act of 1976 required the Port of Long Beach to produce a Master Plan outlining its plans for land use within the Long Beach Harbor District. The California Coastal Commission certified the October 1978 Port of Long Beach Port Master Plan as being in conformance with the policies of the California Coastal Act of 1976. Since 1976, a total of 14 amendments to the Port Master Plan have been certified to reflect changing regulations and long-term goals/objectives, as well as to incorporate anticipated port-related projects. Marine Terminal 2 is a water-dependent use and is in conformance with the Port Master Plan.

East Hynes Terminal

The East Hynes Terminal is located in the City of Long Beach's General Industrial planning district. The district is intended to provide locations for intense industrial and manufacturing activities. No significant changes in the boundaries or composition of this land use district are planned (City of Long Beach, 1997).

Residential development is located adjacent to the northwest portion of the East Hynes Terminal site. This residential development is located in the Cherry Manor neighborhood planning area. No changes to land uses are planned for this neighborhood, however, it is the City's policy to continue a neighborhood improvement program in this area (City of Long Beach, 1997).

Vinvale Terminal

According to the City of South Gate General Plan, approximately 400 acres of land in the City has been designated as mixed-use industrial/commercial. Figure 3.4-4 depicts the terminal site and the land east, southeast, and south of the terminal site as the South Gate Triangle Planning Area, which is almost entirely made up of mixed-use industrial/commercial uses. The plan for this area

calls for the retention of industrial activities while allowing for continued commercial development as appropriate. One of the goals for the South Gate Triangle Planning Area is the development of a high-intensity retail commercial core in the vicinity of the Garfield Avenue/Firestone Boulevard intersection. A 300,000 square-foot retail development is currently under construction to the west of the terminal site, approximately 300 feet north of the intersection of Garfield Avenue and Firestone Boulevard.

Hathaway Terminal

According to the Signal Hill General plan, approximately 31 percent of the land area is zoned for industrial use. The General Plan also indicates that 51 percent of the city is developed to its intended uses, which is a relatively low rate of land use utilization. This low rate is partially due to the large amount of vacant land which remains undeveloped due to a variety of development constraints, including lack of necessary infrastructure, topography, and continued oil production activities.

One of the City of Signal Hill's policies is to discourage the expansion of large storage tank facilities and petroleum refineries (Signal Hill, 1989). Existing oil production activities will continue to be a permitted use, while the interface between these existing oil production activities and other urban uses will be closely monitored.

Colton Terminal

According to the Rialto General Plan, approximately 40 percent of the land area in Rialto is designated for industrial use, and more than half of this industrial land is vacant. Figure 3.4-6 depicts the area south of Solver Avenue and on the west side of Sycamore Avenue as the Aqua Mansa Redevelopment Area.

The City of Rialto, in cooperation with the City of Colton and the Counties of San Bernardino and Riverside, is attempting to attract labor-intensive heavy industry in the area of the terminal to provide job opportunities to local residents (City of Rialto, 1992). However, implementation of planned development has been hampered by the inadequacy of the local infrastructure. As a result, no specific development has been planned for this area (Banuelos, 2000).

3.5 Applicable Hazards Regulations

The following discussion describes laws and regulations affecting the proposed project and the management of risk associated with process upsets.

A variety of safety laws and regulations have been in existence for many years to reduce the risk of accidental releases of chemicals at industrial facilities. Initially, the federal government passed legislation to enhance emergency planning efforts in Title III of the Superfund Amendments and Reauthorization Act (SARA). Next, the U.S. EPA developed Emergency Preparedness and Community Right-to-Know regulations.

The U.S. Department of Labor's California Occupational Safety and Health Administration (OSHA) passed a rule in 1992, known as Process Safety Management of Highly Hazardous Chemicals (29 CFR 1910.119), which addresses the prevention of catastrophic accidents. The rule requires companies handling hazardous substances in excess of specific threshold amounts to develop and implement process safety management (PSM) systems. The requirements of the PSM rule are directed primarily at protecting workers within the facility. One of the key components of the required PSM systems is the performance of process hazard analyses. The process hazard analyses are assessments to anticipate causes of potential accidents and to improve safeguards to prevent these accidents.

In California, Assembly Bill 3777 first required facilities handling Acutely Hazardous Materials (AHMs) to establish Risk Management Prevention Programs (RMPPs) in 1986. The objective of these regulations was to identify facilities that handle AHMs above certain threshold limits and to require these facilities to develop RMPPs to address the potential hazards involved. The RMPPs were intended to identify hazards involving AHMs, evaluate potential consequences of releases, and identify recommended changes in equipment, training, operating, and maintenance procedures, mitigation systems, and emergency response plans to minimize both the potential for these releases and their effects should they occur. The California Office of Emergency Services published guidelines for preparing RMPPs in November of 1989 (OES, 1989). In some cases, administering agencies (usually cities or counties responsible for emergency response and preparedness) have issued additional guidance. The RMPP program has been replaced with the California Accidental Release Prevention (CalARP) Program discussed below.

The EPA established a federal Risk Management Program (RMP) under the Clean Air Act Amendments (CAAA) which were passed in November 1990. The CAAA mandated that EPA create regulations to require facilities possessing listed chemicals above specified threshold amounts to develop and implement RMPs. Facilities storing listed chemicals above specified threshold limits are required to develop and implement RMPs. The RMPs contain a hazard assessment of potential worst-credible accidents, an accident prevention program, and an emergency-response program. Federal regulations were promulgated for RMPs in June 1996 (40 CFR Part 68, Section 112[r]). The Federal RMP was provisionally accepted by California in January 1997 to replace the California RMPP and California regulations. The CalARP program, was finalized by November 1998 (CCR, Title 19, Division 2, Chapter 4.5), as California's version of the RMP. RMP/CalARP regulations require that risk management programs be completed for affected processes by the time a listed substance exceeds the threshold quantity in process for the first time.

3.6 Hazards

In general, hazard impacts are not a discipline with specific environmental characteristics that can be easily described or quantified. Instead, hazard impacts incidents consist of random,

Chapter 3 Setting

unexpected accidental occurrences that may create adverse effects on human health or the environment.

This section describes features of the existing environment as they relate to the risk of a major accident occurring at the LAR and the terminals. Factors which are taken into consideration to determine the magnitude of a risk of an upset event are:

- the probability of an event occurring;
- the types of materials potentially involved in an upset event; and
- the location of sensitive receptors, e.g. residences, schools, and businesses.

Based on a review of the existing LAR and terminal operations and processes, the greatest potential for an upset condition to occur that would affect the public would result from the ignition of flammable material. The most likely flammable material to have an offsite impact would be pentane, which is a flammable liquid stored in large quantities at the LAR and at Marine Terminal 2. Both radiant heat and blast over-pressures could result from ignition of a pentane release. Other events that could have offsite impacts are the release and ignition of pentane from a pipeline rupture or an ethanol release and fire due to a tank truck accident. These types of events are the most likely to occur in an environment such as a refinery and its associated terminals and therefore establish a basis for analysis. (SCAQMD, 1993)

ARCO currently adheres to the following safety design and process standards:

- The California Health and Safety Code Fire Protection specifications.
- The design standards for petroleum refinery equipment established by American Petroleum Institute, American Society of Mechanical Engineers, the American Institute of Chemical Engineers, the American National Standards Institute, and the American Society of Testing and Materials.
- The applicable California Occupational Safety and Health Act (Cal-OSHA) requirements.

ARCO maintains its own emergency response capabilities, including onsite equipment and trained emergency response personnel who are available to respond to emergency situations anywhere within LAR.

LAR also has prepared a Risk Management Program (RMP) for the hazardous materials, butane, pentane and ammonia that are currently used. Risk management program modifications under RMP and CalARP will be required for the new butane and pentane processes associated with this project. The County of Los Angeles Fire Department administers this program. In addition, the LAR has prepared an Emergency Response Manual. This manual describes the emergency response procedures that would be followed in the event of any of several release scenarios and the responsibilities for key response personnel. The scenarios include the release of the following:

- Ammonia stored at bulk tanks currently located at the hydrocracker, #4 steam plant, and the alky units
- Hydrogen sulfide that is a component of a number of intermediate refinery streams
- Natural gas used throughout the refinery involving both ignited and unignited vapors
- Propane or butane leaks involving both ignited and unignited vapors
- Constituents of the petroleum tanks that are located throughout the refinery

3.7 Transportation/Circulation

This section describes the project site in relation to the regional transportation setting. The existing circulation system is discussed, and existing traffic volumes and levels of service are summarized.

3.7.1 Surrounding Highway Network

Regional transportation facilities in the vicinity of the proposed project sites, illustrated in Figure 1.2-1, provide excellent accessibility to the entire southern California region. Four major freeways bound most of the LAR vicinity which is centrally located between two north-south freeways, the Harbor Freeway (Route 110) and the Long Beach Freeway (Route 710). The San Diego Freeway (Interstate 405) lies immediately north of LAR and runs diagonally through the region. The Redondo Beach Freeway (Route 91) lies further to the north of the site and runs east-west. The San Bernardino Freeway (Interstate 10) provides regional access to the Colton Terminal.

In addition to the freeway system, Pacific Coast Highway (Route 1) is immediately south of the LAR site, paralleling the Pacific coastline. Freeway interchanges to the regional arterial highway network provide access at regular intervals.

In addition to the vehicular system, the project locations are serviced by a network of railroad facilities. This system provides an alternative mode of transportation for the distribution of goods and materials. The area is served by the Southern Pacific, Union Pacific, Santa Fe, Pacific Electric, and Harbor Belt Line railroads, with several main lines occurring near the LAR.

Construction traffic generated by the proposed project at the refinery location will access the site via Gate 16 or Gate 62 located on 223rd Street.

Access to the terminals is available via direct routes to regional roadway and freeway facilities. Intersections surrounding the various terminal locations have been included in this analysis. Construction impacts for the LAR site will be of a longer duration. Therefore this study more thoroughly addresses impacts from construction traffic at the LAR.

3.7.2 Existing Traffic Conditions

The LAR is located at 1801 East Sepulveda Boulevard in the City of Carson, California less than one-quarter of a mile south of the San Diego Freeway (I-405). The irregularly shaped parcel that

Chapter 3 Setting

comprises the LAR is generally located between Wilmington Avenue on the west, 223rd Avenue on the north, Alameda Street on the east, and Sepulveda Boulevard on the south.

Twenty-seven intersections have been included in the traffic analysis (Table 3.7-1).

Existing AM and PM peak hour turning movement volumes at these intersections were counted by Traffic Data Services, Inc., and are illustrated in Figures 3.7-1 through 3.7-4. Intersection capacity utilization (ICU) values are presented in Table 3.7-2 and are a means of representing peak hour volume/capacity ratios. (Actual ICU calculations are included in Appendix D.) The ICU is the proportion of an hour required to provide sufficient capacity to accommodate all intersection traffic if all approaches operate at capacity. If an intersection is operating at 80 percent of capacity, then 20 percent of the signal cycle is not used. The signal could show red on all indications 20 percent of the time and the signal would just accommodate approaching traffic. Four intersections (Wilmington and I-405 SB on/off, I-710 NB ramp and Firestone, I-710 SB ramp and Firestone and Garfield and Firestone) are presently operating at an unacceptable level of service during the AM and PM peak hours under existing conditions.

Table 3.7-1 Traffic Intersections Analyzed

LAR and Carson		Vinvale	
1.	Wilmington & I-405 NB on/off	18.	I-710 NB off Ramps & Firestone
2.	Wilmington & I-405 SB on/off	19.	I-710 SB on Ramps & Firestone
3.	Wilmington & 223rd Street	20.	Garfield & Firestone
4.	Wilmington & Watson	T-2 (Marine Terminal)	
5.	Wilmington & Sepulveda	21.	I-710 on/off ramp & Pier B St (T-2)
6.	Alameda & I-405 NB	Colton	
7.	Alameda & 223rd/Wardlow Access	22.	Riverside Dr & I-10 EB on/off ramp
8.	Alameda & Sepulveda (LAR and Carson)	23.	Riverside Dr & I-10 WB on/off ramp
9.	I-405 SB on/off & 223rd/Wardlow	24.	Riverside Dr & Slover Ave
10.	223rd & Alameda/Wardlow access	East Hynes	
11.	Gate 16 & 223 rd	25.	Paramount & SR-91 EB Ramp
12.	Gate 62 & 223 rd	26.	Paramount & SR-91 WB Ramp
Hathaway		27.	Paramount & Artesia
13.	Temple & Willow		
14.	Cherry & Willow		
15.	Cherry & I-405 SB Ramp		
16.	Cherry & I-405 NB Ramp		
17.	Temple & I-405 NB Ramp		

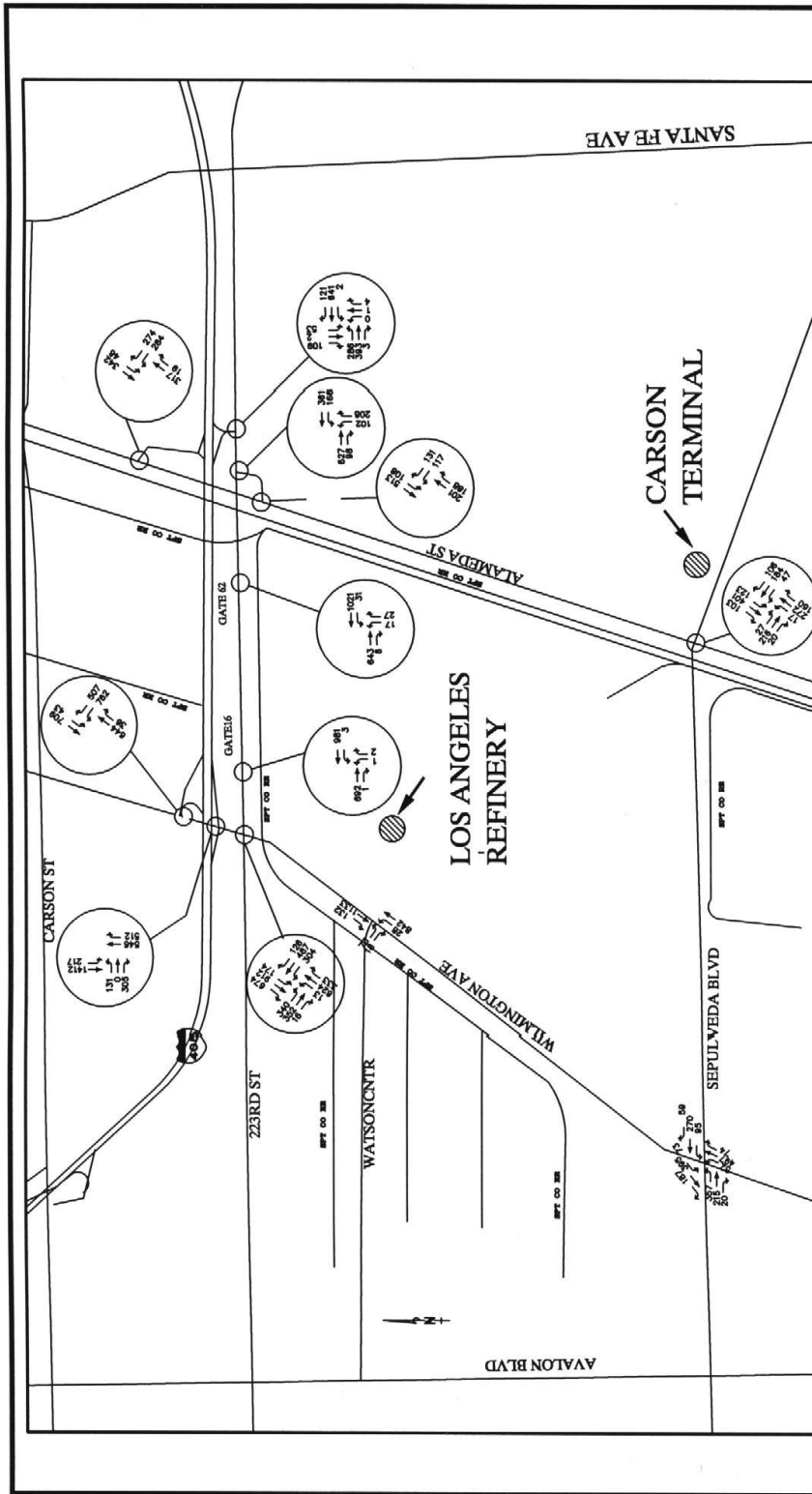

FIGURE 3.7-2

**EXISTING AM PEAK HOUR
TURN VOLUMES (LAR)**

ARCO CARB Phase 3 - MTBE Phase-out Project

Source: Austin-Foust Associates, Inc.
32601.21tg-3.dwg

DRAWN: M. SCOP	DATE: 6/30/2000	PROJECT NO. 0480-479	REV. 0
FILE NO. fig3.6-2	CHK BY: P. Smoker		

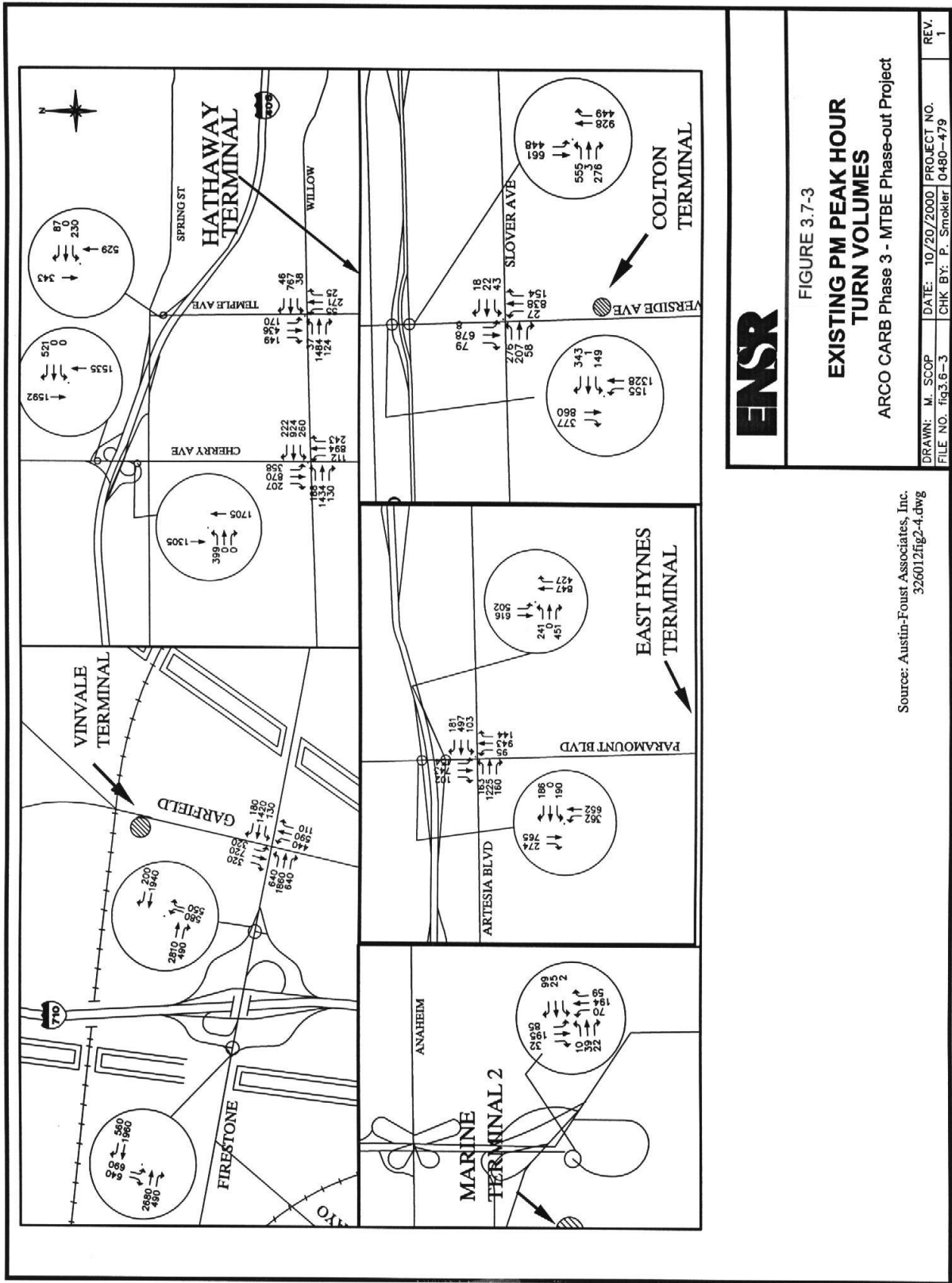

ENSR

FIGURE 3.7-3

EXISTING PM PEAK HOUR TURN VOLUMES

ARCO CARB Phase 3 - MTBE Phase-out Project

Source: Austin-Foust Associates, Inc. 3/26/012fig2-4.dwg

DRAWN: M. SCOP	DATE: 10/20/2000	PROJECT NO.	REV.
FILE NO. fig3.6-3	CHK BY: P. Smokler	0480-479	1

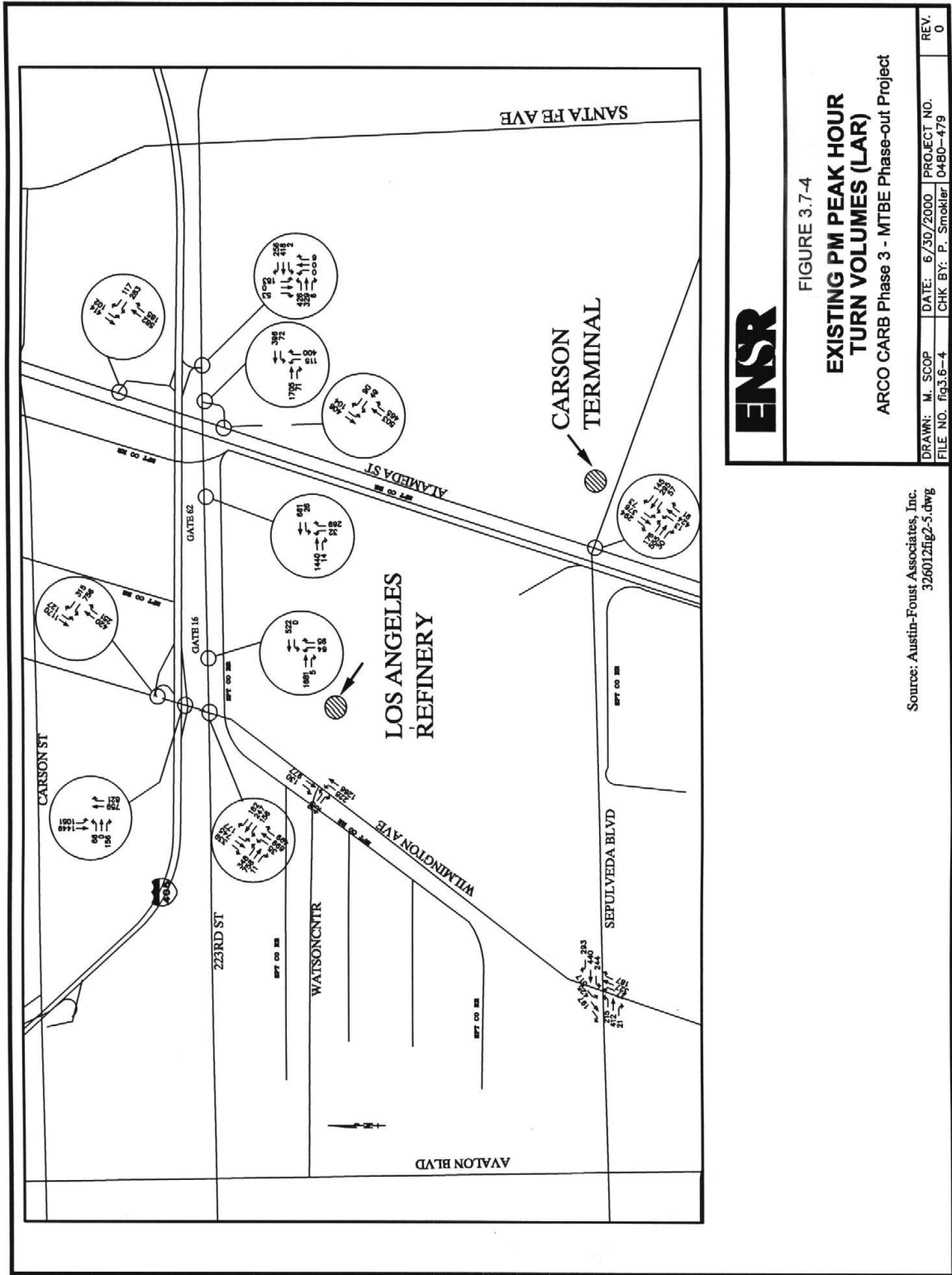

FIGURE 3.7-4

**EXISTING PM PEAK HOUR
TURN VOLUMES (LAR)**

ARCO CARB Phase 3 - MTBE Phase-out Project

Source: Austin-Foust Associates, Inc.
336012fig2-5.dwg

FILE NO. 169316-4	DATE: 6/30/2000	PROJECT NO. 0480-479	REV. 0
DRAWN: M. SCOP	CHK BY: P. Smoker		

**Table 3.7-2
Existing Level of Service Summary**

Intersection	2000 Existing		
	AM	PM	
<u>LAR and Carson</u>			
1. Wilmington & I-405 NB on/off	.73	.67	
2. Wilmington & I-405 SB on/off	.67	1.01	
3. Wilmington & 223 rd	.77	.79	
4. Wilmington & Watson Center	.57	.68	
5. Wilmington & Sepulveda	.63	.87	
6. Alameda & I-405 NB	.41	.52	
7. Alameda & 223/Wardlow Access	.31	.47	
8. Alameda & Sepulveda (LAR and Carson)	.51	.83	
9. I-405 SB on/off & 223/Wardlow	.39	.49	
10. 223rd & Alameda/Wardlow Access	.44	.89	
11. Gate 16 & 223 rd	.41	.73	
12. Gate 62 & 223 rd	.33	.72	
<u>Hathaway</u>			
13. Temple & Willow	.68	.67	
14. Cherry & Willow	.63	.83	
15. Cherry & I-405 SB ramp	.69	.76	
16. Cherry & I-405 NB ramp	.88	.91	
17. Temple & I-405 NB ramp	.44	.41	
<u>Vinvale</u>			
18. I-710 NB off ramp & Firestone	.63	1.03	
19. I-710 SB on & Firestone	.63	1.00	
20. Garfield & Firestone	.93	1.00	
<u>T-2</u>			
21. I-710 on/off ramp & Pier B St	.31	.32	
<u>Colton</u>			
22. Riverside Dr & I-10 EB on/off ramp	.41	.53	
23. Riverside Dr & I-10 WB on/off ramp	.79	.67	
24. Riverside Dr & Slover Ave	.36	.45	
<u>East Hynes Terminal</u>			
25. Paramount & SR-91 EB ramp	.43	.82	
26. Paramount & SR-91 WB ramp	.59	.69	
27. Paramount & Artesia	.70	.93	
Level of service ranges:	.00 - .69 B	.70 - .79 C	.80 - .84 D
	.85 - .89 D+	.90 - .99 E	Above 1.00 F

3.8 Energy Sources

The proposed project facilities will require energy in the form of electricity and fuels during construction and will require electricity and petroleum fuels during daily operations. Electricity required during construction activities is expected to be minimal as the majority of construction machinery is powered by gasoline or diesel fuel. There will be no increase in the amount of natural gas consumed at the project sites as a result of the proposed project.

Electricity is supplied to the areas of Carson, Long Beach, South Gate, Signal Hill, and Rialto by Southern California Edison (SCE). More than 78 billion kilowatt hours of electricity were supplied to customers throughout southern California by the SCE distribution system in 1999 (Alexander, 2000).

Table 3.8-1 below summarizes current electricity use at the project sites.

**Table 3.8-1
Current Electricity Usage**

Project Site	Kilowatt Hours Per Year¹
LAR	665,760,000
Carson	787,214
Marine Terminal 2	12,590,657
Hathaway	1,778,810
East Hynes	6,432,001
Vinvale	1,985,785
Colton	994,564
TOTAL	690,329,031
¹ 1999 data obtained from SCE	

The current energy usage for the LAR and terminals represents 0.01 percent of the total energy demand of users of the SCE distribution system.

California has recently experienced higher-than-expected electric demand and generation shortages due to the deregulation of California's electric industry. Although California has experienced generation shortages and the demand for electricity is expected to increase, the construction of several power plant projects currently being permitted by the California Energy Commission is expected to adequately meet future electricity requirements.

3.9 Solid and Hazardous Waste

Current waste disposal practices for LAR and the terminal areas are presented in this section.

3.9.1 Nonhazardous Solid Waste

The Los Angeles County Sanitation District (LACSD) maintains three landfills in Los Angeles County (Nellor 2000) which serve the LAR, as well as the Carson, Marine Terminal 2, East Hynes, Hathaway and Vinvale terminals. The landfills do not accept liquids or hazardous wastes. Projected closure dates for the three landfills range from 2003 at Puente Hills Landfill to 2023 at Scholl Canyon. Permitted daily capacity ranges from 3,500 tons per day at Calabasas to 13,200 tons per day at Puente Hills (Nellor, 2000).

The Colton terminal is serviced by the San Bernardino County Midvalley landfill located in the City of Rialto. Projected closure date for the landfill is 2033. Permitted maximum daily capacity at the Midvalley landfill is 7,000 tons per day (Hyke, 2000).

A total of 17,335 tons of nonhazardous solid waste were generated at LAR in 1996. Of this amount, 9,259 tons were recycled at offsite facilities and 8,076 tons were disposed of at approved offsite landfills (Van Leeuwen, 2000).

3.9.2 Hazardous Waste

In 1999, a total of 1,510 tons of hazardous waste were generated at LAR. Table 3.9-1 presents each waste category, the volumes generated, and the methods of disposal. During 1999, 965 tons of hazardous waste were landfilled, 372 tons were recycled offsite, and 173 tons of waste were incinerated.

**Table 3.9-1
1999 Volumes of Hazardous Waste Generated at LAR and Methods of Disposal**

Waste Category	Disposal Method	Amount (ton/yr)
Wastewater Solids	Landfilled	0
	Incinerated	166
	TOTAL	166
Hydrocarbons and Contaminated Materials	Landfilled	172
	Incinerated	7
	Recycled	138
	TOTAL	317

**Table 3.9–1 (Cont.)
1999 Volumes of Hazardous Waste Generated at LAR and Methods of Disposal**

Waste Category	Disposal Method	Amount (ton/yr)
Spent Catalysts	Landfilled	145
	Recycled	234
	TOTAL	379
Various Inorganic Solids	Landfilled	66
	TOTAL	66
Asbestos	Landfilled	582

Excavation for the railcar loading improvements at the Northeast Property (former Johns-Manville facility) may generate soils containing asbestos which would require disposal as hazardous waste. To reduce the potential for release of asbestos-containing materials, a site specific Soils Handling Plan has been developed. The Soils Handling Plan provides procedures to prevent airborne release of asbestos fibers and management of asbestos-containing materials should the material be encountered during site activities. The Soils Handling Plan is administered by the LAR Environmental Department.

Terminal operations are limited to the storage and handling of petroleum products and occasional, non-routine tank cleaning and truck washing activities. As a result, hazardous waste generation at the terminals is minimal, as no processing or manufacturing takes place at these sites. The type of hazardous waste generated onsite include tank bottoms clean out, truck wash down water, and commingled hydrocarbon mixtures. These liquid wastes are transported to LAR for treatment/disposal.

3.9.3 Waste Minimization

LAR is actively involved in developing and implementing waste minimization strategies, such as recycling, loss prevention, employee training programs, and waste segregation. The 1999 waste volumes represented a 67 percent reduction in routinely generated hazardous waste over the 1998 rates.

3.10 Public Services

LAR and the terminals are serviced by local public agencies. The Initial Study determined that the only public service agency that could be significantly affected by the proposed project is related to fire protection; therefore, the discussion herein is limited to this issue.

The Los Angeles County Fire Department serves the City of Carson area. The following four stations are located in the area and provide response to the Carson area (Garcia, 2000):

Chapter 3 Setting

- Station 127 at 2049 E. 223rd Street (immediately north of the ARCO Los Angeles Refinery)
- Station 10 at 1860 E. Del Amo Boulevard
- Station 36 at 127 W. 223rd Street
- Station 116 at 755 E. Victoria

All personnel are certified Emergency Medical Technicians. Additionally, Stations 36 and 116 are staffed with paramedics. A specialized foam unit for fighting chemical fires is located at Station 10. Average response time for the stations located in the Carson area to LAR is from two to five minutes (Garcia, 2000).

The LAR fire brigade includes approximately 150 members. The fire brigade provides 24-hour coverage. Four simulated emergency drills are conducted each year involving the whole LAR. The fire brigade is trained biannually at the University of Reno Fire Protection Academy. In addition, the fire brigade receives first-aid training annually, eight hours of training every three months, and one hour per month of in-class emergency training updates. The training includes fire-fighting techniques, spill response, bomb threats, and release scenarios.

The LAR also has a 12-member hazardous materials response team. Members of the team are available for 24-hour onsite coverage. This team receives the same training as the fire brigade with additional emphasis on hazardous material response procedures.

In addition to the training that the fire brigade receives, unit operators are also trained to respond to emergency conditions. Operators test emergency systems such as water sprays, isolation valves, shutdown logic, etc., on a regular basis (i.e., monthly). Operators are also drilled on a regular basis using a series of "what if" scenarios to determine their response to predetermined emergency conditions.

In the event that an operator is unable to control an emergency situation using available fire-fighting or leak control equipment, they initiate the emergency response sequence. The response sequence can be initiated by radio (each operator carries a radio unit) or by phone (control room) or by activating a unit emergency pull box. Unit pull boxes are currently being replaced by emergency field telephones. Training is conducted annually to inform the unit operators when they are expected to initiate the emergency response sequence.

When the emergency response sequence has been initiated, key management personnel are paged automatically. During off-hours, a telephone call system is also used in addition to the page system to contact the most critical management personnel.

Unit supervisors are required to go to their units (even if that area is not directly involved in the emergency). Other management personnel respond to the fire brigade and others to the management command center.

All management personnel involved in emergency response activities receive annual eight-hour training (along with all personnel) and in addition participate in a quarterly practice drill.

The following two stations provide response to the Vinvale terminal area (Garcia, 2000):

- Station 54 at 4867 Southern Avenue
- Station 57 at 5720 Gardendale

Station 54 has an average response time of four minutes (Olson 2000) and Station 57 has a response time of three minutes (Alpert 2000) to the Vinvale terminal.

The Marine Terminal 2, East Hynes, and Hathaway terminals are serviced by the Long Beach Fire Department (Geral 2000). Marine Terminal 2 is serviced by the Long Beach Fire Department, Station 24 located at 611 Pier T Avenue, located approximately 3.1 miles away. Station 24 has a response time of four minutes (Henry, 2000). The East Hynes terminal is serviced by the Station 12, located at 6509 Gundry Avenue, approximately 1.8 miles away. Station 12 has an approximate response time of four minutes (Henry, 2000). The Hathaway terminal is serviced by the Long Beach Fire Department, Station 17 located at 2241 Argon Avenue, approximately 1.5 miles away and Station 23 located at 2300 E. 27th Street in Signal Hill. The response time for Station 23 to the Hathaway terminal is approximately three to four minutes (Henry, 2000).

The Colton terminal is serviced by the Rialto Fire Department, Station 1 located at 131 South Willow Street, approximately three miles away. The response time for Station 1 is 7.5 to 9.5 minutes (Bailey, 2000).

3.11 Cultural Resources

It was determined in the Initial Study that there exists the potential for significant environmental impacts to cultural resources at the LAR and not at the other sites associated with the proposed project. Therefore this EIR addresses cultural resources only at the LAR location.

3.11.1 Los Angeles Refinery Area

Prehistory: The LAR site lies within the historic territory of the Native American group known as the Gabrielino or Tongva, one of the wealthiest, most populous, and most powerful ethnic nationalities in aboriginal southern California (Bean and Smith, 1978). The native word Tongva has been used to designate what were previously call Gabrielino speakers and is a preferred designation by many people native to the area (King, 1994). The Tongva/Gabrielino followed a sophisticated hunter-gatherer lifestyle, and were a deeply spiritual people (McCawley, 1996). Their historic territory included the Los Angeles Basin (which includes the watersheds of the Los Angeles, San Gabriel, and Santa Ana Rivers), the coast from Aliso Creek in the south to Topanga Creek in the north, and the four southern Channel Islands. Prior to the arrival of the Tongva/Gabrielino's Shoshonean speaking ancestors into southern California, the archaeological record indicates that sedentary populations occupied the coastal regions of California more than

9,000 years ago (Erlandson and Colten, 1991). Several chronological frameworks have been developed for the Tongva/Gabrielino region including Wallace (1955) and Warren (1968).

History. The LAR falls within the historic territory of *Rancho San Pedro*, a 75,000 acre Spanish Land Grant deeded to Juan Jose Dominguez for services rendered to the crown (Bonner, 1999). Jose Dominguez's nephew, Manuel Dominguez, eventually inherited the Rancho, which he later passed on to his six daughters. It was Dominguez's second daughter's son, Patrick Watson, who sold the current LAR property to the Pan American Refinery Company in 1923. The land was later sold to Richfield Oil, now ARCO (Bonner, 1999).

3.11.2 Site Specific Setting

An archival record search for the LAR was conducted at the South Central Coastal Information Center in October 1998 by W.H. Bonner Associates. This information was updated with (1999) archaeological site record information provided by Solstice Archaeological Consulting and supplemented by technical papers on CA-LAN-2682 in preparing this section.

There is one archaeological site, CA-LAN-2682, within LAR's boundaries and one archaeological site, CA-LAN-98, immediately adjacent to the refinery, which may extend into the property. A description of both of these sites is provided below:

CA-LAN-2682 (the ARCO site) is a 15 by 15 meter (50 by 50 ft.) Native American Indian site that was exposed during subsurface excavation for replacement of existing underground utility lines in 1998.

CA-LAN-98 is the village site of *Suangna*, which may have been occupied as late as 1813 (McCawley, 1996). Located near the intersection of Wilmington Avenue and Sepulveda Boulevard in Carson it was first excavated by Racer in 1910 and later by Eberhart in 1967 and Dominguez College in 1970. Racer describes the site as covering an area of 183 by 244 meters (610 by 813 ft.). Los Angeles Historical Marker No. 13 commemorates the village site location.

The Gabrielino/Tongva Tribal Council has stated that the LAR property has a special archaeological significance to the tribe (Dunlap, 2000). In a letter dated June 16, 2000, Tribal Spokesperson Samuel Dunlap notes "...Since the discovery of human remains and prehistoric artifacts in September of 1998 on the ARCO property, it is apparent that the potential for uncovering additional Indian burials and cultural material is significant enough to warrant archaeological and Native American monitoring during any future construction activities."

3.11.3 Regulatory Setting

3.11.3.1 California Environmental Quality Act (CEQA)

The State of California has formulated laws for the protection and preservation of archaeological resources. Generally, a cultural resource shall be considered to be "historically significant" if the

resource meets the criteria for listing on the California Register of Historic Resources (Pub. Res. Code §5024.1, Title 14 CCR, §4852) including the following:

1. Is associated with events that have made a significant contribution to the broad patterns of California's history and cultural heritage;
2. Is associated with the lives of persons important in our past;
3. Embodies the distinctive characteristics of a type, period, region, or method of construction, or represents the work of an important creative individual, or possesses high artistic values; or
4. Has yielded, or may be likely to yield, information important in prehistory or history.

The fact that a resource is not listed in, or determined to be eligible for listing in the California Register of Historical Resources, not included in a local register of historical resources (pursuant to §5020.1(k) of the Public Resources Code), or identified in an historical resources survey (meeting the criteria in §5024.1(g) of the Public Resources Code) does not preclude a lead agency from determining that the resource may be an historical resource as defined in Public Resources Code §5020.1(j) or 5024.1.

If the project may cause damage to a significant cultural resource, the project may have a significant effect on the environment. CEQA Guidelines §15064.5 pertains to the determination of the significance of impacts to archaeological and historic resources. CEQA provides guidelines for administering to archaeological resources that may be adversely affected by project development in §15126.4. Achieving CEQA compliance with regard to treatment of impacts to significant cultural resources requires that a mitigation plan be developed for the resource(s). Preservation in place is the preferred manner of mitigating impacts to archaeological resources.

3.11.3.2 California Register of Historical Resources

Drafted in 1995, the California Register of Historical Resources provides proposed guidelines for the nomination of properties to the California Register. The California Register is an authoritative guide to be used by state and local agencies, private groups, and citizens to identify the state's historical resources and to indicate which properties are to be protected, to the extent prudent and feasible, from substantial adverse change. The criteria for listing resources on the California Register are based on those developed by the National Park Service for listing on the National Register of Historic Places with modifications in order to include a broader range of resources which better reflect the history of California.

3.11.3.3 California Public Resources Code

California Public Resources Code §5097.9 stipulates that it is contrary to the free expression and exercise of Native American religion to interfere with or cause severe irreparable damage to any Native American cemetery, place of worship, religious or ceremonial site, or sacred shrine.

3.11.3.4 State Health and Safety Code

If human remains are exposed during construction, State Health and Safety Code §5097.9 of the 7050.5 requires that no further disturbance shall occur until the County Coroner has made the necessary findings as to origin and disposition pursuant to Public Resources Code §5097.9 of the 5097.98. If the remains are determined to be of Native American descent, the coroner has 24 hours to notify the Native American Heritage Commission (NAHC). The NAHC will then contact the most likely descendent of the deceased Native American, who will serve as a consultant on how to proceed with the remains.

3.12 Geology and Soils

Of the proposed project components, only the LAR and Marine Terminal 2 will undergo new construction, excavation or grading and, therefore, the following discussion of geological hazards is limited to these two sites. The other project components including the Carson, Colton, East Hynes, Hathaway, and Vinvale terminals will require only minor pipe system re-fitting, without excavation or construction, and these remote terminal sites will be excluded from the geologic hazards discussion.

Southern California is characterized by a variety of geographic features that form the basis for subdividing the region into several geomorphic provinces. The LAR and its terminals are located within the northwestern portion of the Peninsular Range Province, a major physiographic and tectonic province characterized by a prevailing northwesterly orientation of structural geologic features. This general area, known as the Los Angeles Basin, is a northwest-trending lowland plain approximately 50 miles long and 20 miles wide. The lowland surface of the Los Angeles basin slopes gently southward and westward to the Pacific Ocean.

The Newport-Inglewood structural zone extending from Newport Bay northwest to Beverly Hills interrupts the gentle southward and westward slope of the Los Angeles Basin. This feature is expressed topographically as a line of low discontinuous hills and ridges. Although urbanization has resulted in intensive localized alteration of the natural topography within the Los Angeles Basin, the general topographic character of the landscape has not been modified.

3.12.1 Structural Setting

The Peninsular Ranges Province has a characteristic structural grain consisting of northwest-trending faults and associated structural basins. The Newport-Inglewood Fault Zone dominates the geologic structure of the area encompassing the LAR and the Marine Terminal 2, and represents the most significant potential sources of strong ground shaking for these sites. The northwest-trending Newport-Inglewood Fault Zone is marked at the surface by low eroded scarps along en echelon faults and by a northwest-trending chain of elongated low hills and mesas that extend from Newport Bay to Beverly Hills (CDMG 1998). Orientation of the structural elements of the zone is generally attributed to right-lateral, strike-slip faulting.

The Newport-Inglewood fault is located approximately 4.3 miles northeast of the LAR and is one of the most significant tectonic structures in the area of the proposed project.

The occurrence of numerous earthquakes along the Newport-Inglewood fault zone in historic time graphically demonstrates the Holocene ($\leq 11,000$ years old) activity of the structure. Most notable of these is the magnitude 6.3 Long Beach earthquake that occurred in 1933. Within the past 30 years, an annual average of between two and three local earthquakes in the magnitude range of 3 to 4.5 have been recorded at various locations along the zone.

Another potentially significant fault in the immediate area of the LAR and Marine Terminal 2 is the Palos Verdes fault zone, which is located approximately 6.2 miles southwest of the LAR. The fault extends from the Redondo submarine canyon in Santa Monica Bay to south of Lasuen Knoll, a distance of 43 miles. The fault is characterized by both right-lateral strike-slip and southwest-side up reverse separation and is responsible for uplift of the Palos Verdes Peninsula.

3.12.2 Seismicity

Southern California is a seismically active area for which there are good to excellent historic records available for the last 150 to 200 years. Instrumental seismic records are available for the past 50 years. Earthquake magnitudes are expressed using the Richter scale, a log scale generally ranging from 0 to slightly less than 9.0.

The greatest concentration of seismic events in the Long Beach area has resulted from activity on the Newport-Inglewood fault zone and is primarily related to the 1933 Long Beach earthquake and its aftershocks. There is a strong correlation between the distribution of seismic events and the location of major faults. This correlation is particularly true for events greater than magnitude 6.0. The proximity of major faults to the project location areas increases the probability that an earthquake of magnitude six or greater may affect the project site. A magnitude seven or higher earthquake would be capable of adversely affecting most existing structures in the project vicinity.

3.12.2.1 Important Historic Earthquakes/Earthquake Probability

Several large, historic earthquakes have affected the area, encompassing the LAR and Marine Terminal 2. Most of the magnitude four or greater earthquakes in the area have been associated with the Newport-Inglewood fault zone. At least five destructive earthquakes have occurred along this fault since 1926.

By 1998 the California Division of Mines and Geology (CDMG) had completed a seismic hazard evaluation study of the Long Beach Quadrangle (CDMG, 1998), an analysis which included the project sites and an evaluation which forms the basis for the following discussion on seismic hazards. Available historic local and regional seismic records were compiled, and used to develop defensible and site specific seismic hazard analyses. The hazard analysis, in particular, was designed to predict earthquake-induced ground motions capable of causing ground failure (liquefaction, landslides) for the area including the project sites.

In the CDMG hazard evaluation, the ground shaking levels in the area encompassing the project were estimated for each of the sources (local or regional faults capable of generating an earthquake) included in the seismic source model using attenuation relations that relate earthquake shaking with magnitude, distance from the earthquake, and type of fault rupture (strike-slip, reverse, normal, or subduction).

In the hazards evaluation the CDMG included the hazards associated with ground motion exceeding peak horizontal ground acceleration (PHGA) at 10 percent probability of exceedance in 50 years (CDMG 1998). For the LAR and Marine Terminal 2 area, the ground motion evaluation predicted that PHGA could range between 0.45g and 0.59 g, resulting from an earthquake of Magnitude 7.1 located at a fault source approximately 4.3 miles away (assumed to be the Newport-Inglewood Fault).

3.12.2.2 Ground Rupture - Earthquake Zoning

The Newport-Inglewood fault zone, which dominates the geologic structure of the area encompassing the LAR and the Marine Terminal 2, is designated as a special studies zone according to the Alquist-Priolo Special Studies Zones Act. This act specifies that an area, termed an 'Earthquake Fault Zone' is to be delineated surrounding faults that are deemed “sufficiently active” or “well defined” after a review of seismic records and geological studies. This legislation was passed to prohibit the location of most structures for human occupancy across the traces of active faults and to mitigate thereby the hazard of earthquake-induced ground rupture. Cities and counties affected by zones must regulate certain existing and development projects within the zones by permitting and building code enforcement (CDMG, 2000).

Both the LAR and the Marine Terminal 2 are located near the Newport-Inglewood Fault. However, neither is located in a designated “earthquake fault zone” as defined by the Alquist-Priolo Special Studies Zone Act mapping, and is thus considered to have an insignificant potential for earthquake-induced ground rupture due to the Newport-Inglewood fault.

3.12.2.3 Subsidence

Subsidence is the vertical displacement of the ground surface. Human-induced subsidence of land in the southwest portion of the Los Angeles Basin was first observed in the Wilmington oil field south of the project area in 1937. The removal of oil, water, and gas in this and neighboring oil fields allowed the rock and mineral grains in the oil reservoirs to pack together more closely, reducing bed thickness and causing subsidence of the ground surface.

Human-induced withdrawal of oil from the 1920's to the 1950's in the Long Beach area caused subsidence up to 70 feet. The Marine Terminal 2 area had a subsidence of five to seven feet (Association of Engineering Geologists, 1969). In the late 1950's, the California State Legislature required mitigation measures such as fluid re-injection, and, as a result subsidence in the area has been arrested and ground surface stability re-established.

3.12.3 Soils (Surficial Geology)

The LAR is underlain by two mappable surficial geology units, comprising older and younger alluvium. Similarly, Marine Terminal 2 is underlain by two surficial geology units which include artificial fill and younger alluvium (CDMG, 1998). These surficial units are diversified in both description and susceptibility to seismic hazard. Table 3.12-1 presents descriptions of the soil types in the vicinity of the LAR and Marine Terminal 2.

**Table 3.12-1
Surficial Geology Units at LAR and Marine Terminal 2**

Geologic Map Unit	Material Type	Consistency	Liquefaction Susceptibility	Expansive Potential
LAR NE Corner of site: <u>Qya2</u> - Younger alluvium	Clay, silt, silty sand, and sand	Soft	High	Low
LAR SW Corner of site: <u>Qoa</u> - Old Alluvium	Silty sand, minor gravel	Dense to very dense	Low	Low
Marine Terminal 2, north half of site: <u>Qya2</u> - Younger Alluvium	Clay, silt, silty sand, and sand	Soft	High	Low
Marine Terminal 2, south half of site: <u>Af</u> - Artificial Fill	Artificial Fill, usually dredge spoils	Soft to dense	High	Low

3.12.3.1 Expansive Soils

Expansive soils have the ability to shrink and swell with wetting and drying. The shrink-swell capacity of expansive soils can result in differential movement beneath foundations. Investigation of the LAR and Marine Terminal 2 sites indicates that the majority of the near surface soils are granular in nature. Accordingly, the expansion potential of site soils is anticipated to be low.

3.12.3.2 Soil Liquefaction

Soil liquefaction is a phenomenon in which saturated, cohesionless soils (sand) temporarily lose their strength and liquefy when subjected to dynamic forces such as intense and prolonged ground shaking. Liquefaction typically occurs when the water table is less than 40 feet below ground surface and the soils are predominantly granular and unconsolidated. The potential for liquefaction increases as the groundwater approaches the surface. Recent analysis of seismic hazards in California by the CDMG indicates that the northeast portion of the LAR and the entire area of the Marine Terminal 2 location are areas where historic occurrence of liquefaction indicate a potential for permanent ground displacements (CDMG, 1999).

3.12.3.3 Landslides

Landslides involve the downslope movement of masses of soil and rock material under gravity. Landslides can be caused by ground shaking, such as earthquakes, or heavy precipitation events. Generally, landslides occur on the sideslopes of mountains comprised of sedimentary materials. Sedimentary rocks are particularly susceptible to landslides because they often contain relatively

less competent beds of clays and other fine-grained rocks interbedded with more competent beds of sand and gravel. Recent analysis of seismic hazards in California by the CDMG indicates that neither the LAR nor the Marine Terminal 2 are within areas where previous occurrence of landslide movement indicate a potential for permanent ground displacements (CDMG, 1999).

3.12.3.4 Soil Contamination

The only major excavation planned related to these projects is located at the LAR for the retention pond proposed as secondary containment for butane/pentane rail cars in the loading racks area. This excavation could involve up to 3,000 cubic yards of soil.

Analytical profiles (laboratory analyses) conducted on soils previously excavated from other portions of the LAR have indicated that approximately 90 percent of the soil was classified as nonhazardous and 10 percent was classified as a California hazardous waste.

Affected nonhazardous soil from LAR is currently recycled offsite at the American Remedial Technologies facility in Lynnwood, California. Affected hazardous soil from the LAR is currently transported and disposed of by Chemical Waste Management at their Kettleman Hills, California Class 1 facility or Safety Kleen at their Buttonwillow, California Class 1 Facility.

ARCO will sample and analyze soils within the vicinity of the proposed units prior to construction. It is anticipated that this soil will have similar characteristics to that of previously excavated soil. Such soil will be handled in accordance with the appropriate federal, state and local regulations. No significant impacts are associated with this limited excavation activity.

3.13 Other Issue Areas Eliminated During the Initial Study

Based on the assessment completed for the IS, the following areas were eliminated from further consideration in this EIR:

- Aesthetics
- Agricultural Resources
- Biological Resources
- Mineral Resources
- Population/Housing
- Recreation

No scenic vistas or scenic resources are located in proximity to LAR or the terminals. Additionally, no biological, agricultural, or mineral resources exist at the project sites. Thus, these issue areas would not be impacted. Labor would be drawn from a well-supplied local pool and there would be no or minimal influx of workers for either construction or operation; therefore, there would be no impacts to population/housing or recreation. For a more complete treatment of these issue areas, please refer to the IS in Appendix A.